

PTH

**PARIS TEXAS
HARDWARE**

2014 Drapery Hardware Catalog

MDS
WINDOW FASHIONS

Midwest
Designer
Supply

888-523-2611

Details matter.

When every aspect of a design is carefully considered, the resulting creation is truly distinctive.

And when a brand pays fanatical attention to every product detail - deliberately curating every collection, year after year - exceptional design becomes its defining signature.

Since 1992, Paris Texas Hardware has been devoted to providing exclusive collections of drapery hardware, featuring nothing but one-of-a-kind products. Our designs have always been, and will always be, uniquely our own. Whether it's a final silhouette that has never been seen before or an Old World classic with a new world twist, we promise to provide you with something different – something that you cannot find anywhere else in the world.

We painstakingly pore over every detail and edit each collection of our drapery hardware products – always with your ultimate creative inspiration in mind.

Paris Texas Hardware Mission

With a dedication to exceptional design and superior service, Paris Texas Hardware will provide a unique, elegant, and high quality selection of decorative drapery hardware and accessories. We believe all of our products will be unrivaled in their ability to stand alone as decorative, durable, and functional. Paris Texas Hardware will offer an enjoyable customer experience that includes honest dialogue and responsive feedback.

DESIGNED TO INSPIRE.

Table of Contents:

Portfolio

Ships in 10 - 15 business days

30 custom hand-painted finishes

Portfolio 1"	1
1" Hand Drawn Traverse System	15
Portfolio 1¼"	17
Portfolio 1⅜"	25
Portfolio 2"	33
Portfolio 2¼"	39
Portfolio Holdbacks	49
Portfolio Finishes	53
PTH Perfect Match™	56

Corded and Motorized Traverse

Ships in 10 - 15 business days

30 Portfolio and 5 Quick Ship Wood and Resin finishes

Corded Traverse	61
EasyPull™ Heavy-Duty System.....	62
EasyPull™ Light-Duty Basic White System	63
Heavy-Duty Ball Bearing System	65
Motorized Traverse	67
BTX DC Motorized System	67
Somfy Glydea™ Motorized System	67

Quick Ship

Ships in 1 business day

5 Quick Ship Metal finishes

Quick Ship Metal 1"	69
1" Hand Drawn Traverse System	79

3 Luxe Line finishes

Quick Ship Luxe Line Hand Drawn Traverse System	81
---	----

5 Wood and Resin finishes

Quick Ship Wood and Resin 1⅜"	85
Quick Ship Wood and Resin 2¼"	89

Portfolio

The complete range of Paris Texas Hardware finials and accessories, including all hardware from Quick Ship Metal and Quick Ship Wood and Resin.

1", 1¼", 1⅜", 2", and 2¼" diameters

30 custom hand-painted finishes

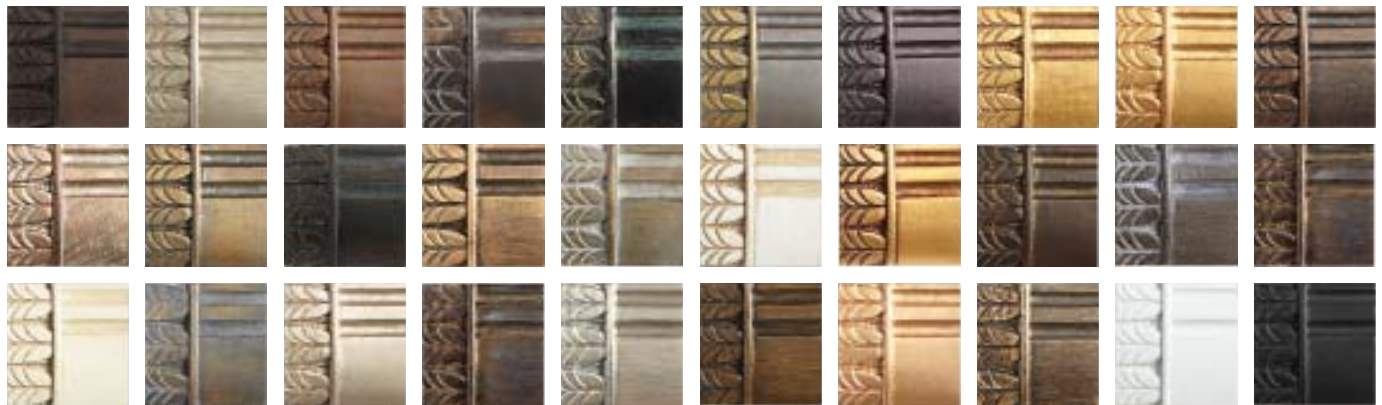

PTH Perfect Match™:
thousands of Benjamin Moore® colors

10 -15 business day lead time

Portfolio
1"

Available in 30 Portfolio finishes (shown on pages 54-55) and unlimited PTH Perfect Match™ finishes (see pages 56-60).

PORTFOLIO 1"



1" Modern Metal Finials *Not compatible with 1" Hand Drawn Traverse System.*

*Remember:
Luna End Cap
covers 3/8" of the
pole. Finished
pole length may
need to be
increased
accordingly.



Luna End Cap*
PO100LUEC
3/4" W
1 1/2" DIA
Antique Gold



Ella
PO100ELAFI
1 1/2" W
1 5/8" DIA
Shimmer



Lex
PO100LXFI
1 1/2" W
2" DIA
Dark Chocolate



Cole
PO100COFI
3 1/4" W
1 1/2" DIA
Mink



Elm
PO100EMFI
1 1/2" W
2" DIA
Halo



Nora
PO100NOFI
2" W
2 1/4" DIA
Firelight



Knox - Crystal
PO100KNFI
1 1/4" W
2 1/4" DIA
pole shown in Starlet



Elm - Smoke Glass
PO100EMFIGL
1 1/2" W
2" DIA
Urban Bronze



Nora - Mercury Glass
PO100NOFIGL
2 1/8" W
2 3/8" DIA
Black



Enhance your Modern Finial

Position a 1" Band against the base of your 1" Modern Metal Finial.



Embellish your Pole

Install 1" Bands anywhere along the length of your pole... spread them out or stack them side by side for a dramatic effect.



Need Some Glamour?

Dress up your Modern Finial: Add a 1" Band



1" Modern Metal Finial Accessories

- Only for use with 1" diameter pole.
- Not recommended for 1" Hand Drawn Traverse.



1" Braided Band
 PO100BRBAND
 5/8" W
 1 5/8" DIA
 Antique Gold Leaf
 • Resin; available in any Portfolio Finish.



1" Crystal Band
 PO100CRMEBAND
 5/8" W
 1 5/8" DIA
 • Metal; available only in dark metal with inlaid crystals.



How To Add Your Band:



Before installing your 1" Modern Metal Finials, simply slide each Band into position on your 1" pole.



Install finials. Secure each Band by tightening set screw.

TIP:
1" Bands cover 5/8" of pole!



PORTFOLIO 1"



1" Transitional Metal Finials* *Compatible with 1" Hand Drawn Traverse System. See page 15.*

***Remember:**
Each finial on this page covers $\frac{5}{8}$ " of the pole. Finished pole length may need to be increased accordingly.



Luna End Cap
PO100LUEC
 $\frac{3}{4}$ " W
1 $\frac{1}{4}$ " DIA
Titanium



Ella with Cuff
PO100ELAFICU
2 $\frac{1}{4}$ " W
1 $\frac{5}{8}$ " DIA
Andiron



Lex with Cuff
PO100LXFICU
2 $\frac{1}{2}$ " W
2" DIA
Mystic



Cole with Cuff
PO100COFICU
4" W
1 $\frac{1}{2}$ " DIA
Java



Elm with Cuff
PO100EMFICU
1 $\frac{7}{8}$ " W
2" DIA
Parchment



Nora with Cuff
PO100NOFICU
2 $\frac{3}{4}$ " W
2 $\frac{1}{4}$ " DIA
Firelight



Knox - Crystal with Cuff
PO100KNFICU
2" W
2 $\frac{1}{4}$ " DIA
Antique Gold



Elm - Smoke Glass with Cuff
PO100EMFIGLCU
1 $\frac{7}{8}$ " W
2" DIA
New Age Bronze



Nora - Mercury Glass with Cuff
PO100NOFIGLCU
2 $\frac{7}{8}$ " W
2 $\frac{3}{8}$ " DIA
Barnwood

Enhance your Transitional Finial

Install the Traditional Collar between the Finial and its Cuff. The Collar's turned design and classic contour add Traditional styling to an otherwise Transitional look.



Today's Traditional

Refine your Transitional Finial: Add a Traditional Collar!

1" Transitional Metal Finial Accessory



Traditional Collar

POTRADCO

5/8" W

1 1/8" DIA

Titanium

- Metal; available in any Portfolio finish.
- Can only be added to 1" Transitional Metal Finials. (Finials maintain compatibility with 1" Hand Drawn Traverse.)

*TIP:
Traditional Collar
also looks great
in a
contrasting
finish!*

How To Make It Traditional:



Unscrew the Transitional Finial from its Cuff.



Screw Finial into the Traditional Collar. Screw Traditional Collar into the Cuff.

PORTFOLIO 1"



1" Textured Metal Finials *Can be adapted to fit 1" Hand Drawn Traverse System by adding a 1" Cuff. See page 13.*



Marcus End Cap
PO100MREC
1/2" W
1 1/2" DIA
Linen



Achilles
PO100ACFI
4 1/4" W
1 1/4" DIA
Urban Bronze



Tybalt
PO100TBF1
1 7/8" W
1 1/8" DIA
Firelight



Grapefern
PO100GPF1
5" W
3 3/4" DIA
Amulet



Hector
PO100HEF1
5 7/8" W
5 3/8" H
1 1/2" D
Gossamer



Larkspur
PO100LRF1
6 3/8" W
5 1/8" H
1 1/2" D
Andiron



Cassia
PO100CSFI
4 1/2" W
2 3/8" DIA
New Age Bronze



Demetrius
PO100DMFI
3" W
2 3/8" DIA
Starlet



Strato
PO100STFI
3 1/8" W
3 1/8" DIA
New Age Bronze



Nerissa
PO100NEFI
4 1/2" W
3 1/4" DIA
Mystic

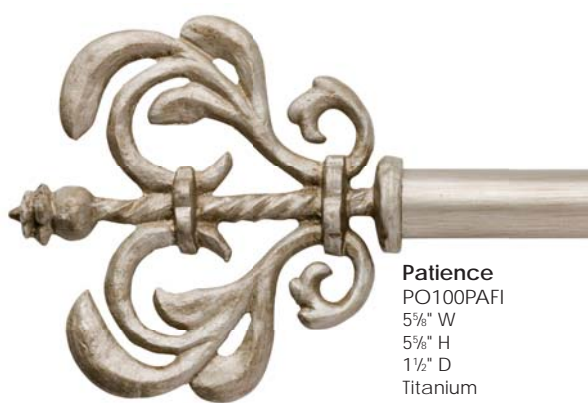

Patience
PO100PAFI
5 5/8" W
5 5/8" H
1 1/2" D
Titanium

1" Textured Metal Finials look great with these 1" Finial Accessories. MUST BE ORDERED SEPARATELY. SEE PAGE 13.

Patience
+
1" Crystal
Band



Achilles
+
1" Cuff



PORTFOLIO 1"



1" Glamour Resin Finials *Can be adapted to fit 1" Hand Drawn Traverse System by adding a 1" Cuff. See page 13.*

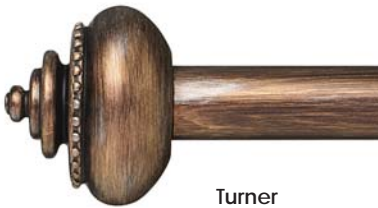

Turner
PO100TUF1
2 1/4" W
2 3/4" DIA
Moonlight



Clara
PO100CLRF1
2 1/4" W
2 3/8" DIA
Starlet



Fairbanks
PO100FBF1
3 1/8" W
2" DIA
Halo



Chaplin
PO100CHF1
1 3/4" W
2" DIA
Black



Pickford
PO100PIF1
2 1/4" W
1 7/8" DIA
Amulet



Astor
PO100ASF1
1 3/8" W
2 3/8" DIA
Firelight

1" Glamour Resin Finials look great with these 1" Finial Accessories. MUST BE ORDERED SEPARATELY. SEE PAGE 13.

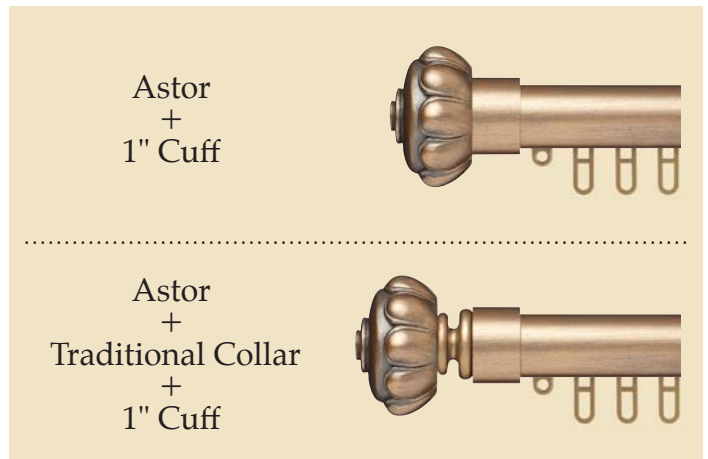
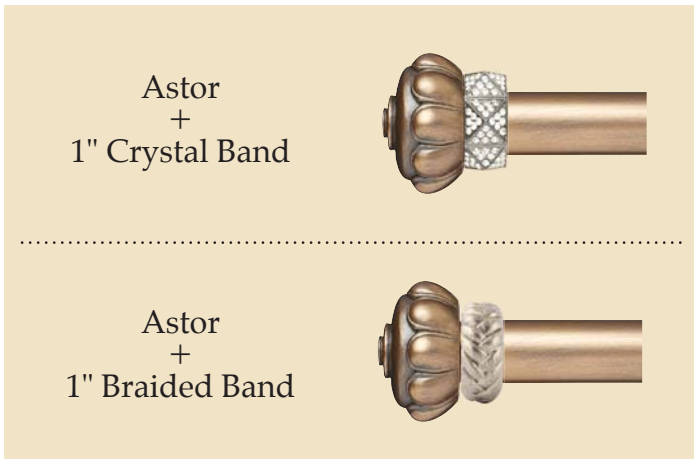

1" Pearl Resin Finials: 3 Pearl Colors. 3 Gorgeous Styles.

1" Jewel Pearl Resin Finials

Pearl available in white, cream, or grey. Base available in any Portfolio Finish.



White Pearl Jewel
PO100PEJWFI - WH
2 1/4" W
2 3/8" DIA
Base and pole
shown in Halo



Cream Pearl Jewel
PO100PEJWFI - CR
2 1/4" W
2 3/8" DIA
Base and pole
shown in Halo



Grey Pearl Jewel
PO100PEJWFI - GY
2 1/4" W
2 3/8" DIA
Base and pole
shown in Halo

1" Transitional Pearl Resin Finials *Compatible with 1" Hand Drawn Traverse System!*

Pearl available in white, cream, or grey. Cuff available in any Portfolio Finish.



White Pearl with Cuff
PO100PEFICU - WH
2 1/4" W
1 5/8" DIA
Cuff and pole shown
in Spun Gold



Cream Pearl with Cuff
PO100PEFICU - CR
2 1/4" W
1 5/8" DIA
Cuff and pole shown
in Spun Gold



Grey Pearl with Cuff
PO100PEFICU - GY
2 1/4" W
1 5/8" DIA
Cuff and pole shown
in Spun Gold

1" Modern Pearl Resin Finials

Pearl available in white, cream, or grey.



White Pearl
PO100PEFI - WH
1 1/2" W
1 5/8" DIA
pole shown in
Dark Chocolate

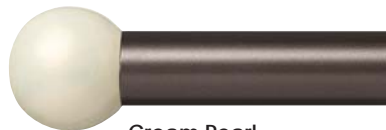

Cream Pearl
PO100PEFI - CR
1 1/2" W
1 5/8" DIA
pole shown in
Dark Chocolate



Grey Pearl
PO100PEFI - GY
1 1/2" W
1 5/8" DIA
pole shown in
Dark Chocolate

1" Modern Pearl Resin Finials look great with these 1" Finial Accessories. MUST BE ORDERED SEPARATELY. SEE PAGE 13.

Modern Grey Pearl
+
1" Crystal Band

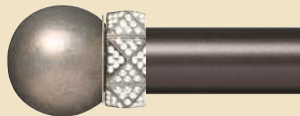

Modern White Pearl
+
1" Braided Band



TIP:
1" Cuff and Traditional Collar
are available in
Quick Ship Brushed Nickel finish.
Refer to Quick Ship Metal 1" Price List
for more information.



1" California Resin Finials *Can be adapted to fit 1" Hand Drawn Traverse System by adding a 1" Cuff. See page 13.*



1" California Front-Facing Finial Kits

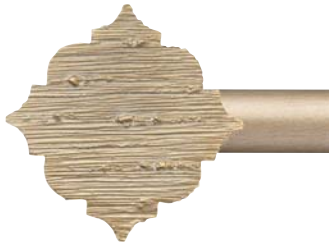

Sunset Finial Kit
 PO100SUKIT
 3/4" W
 3 1/2" DIA
 Mystic



Newport Finial Kit
 PO100NEKIT
 3/4" W
 3 1/4" DIA
 Gossamer

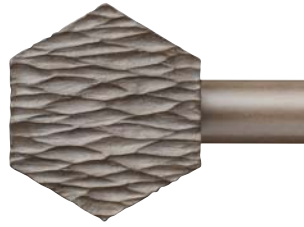

Laguna Finial Kit
 PO100LGKIT
 3/4" W
 3 3/8" DIA
 Barnwood



Venice Finial Kit
 PO100VEKIT
 3/4" W
 3 1/2" DIA
 Parchment

Kits include the following:

- 1 pair 1" Luna End Caps
- 1 pair 1" Holdback Medallion Bands
- 1 pair California End Caps



TOP VIEW WHEN INSTALLED

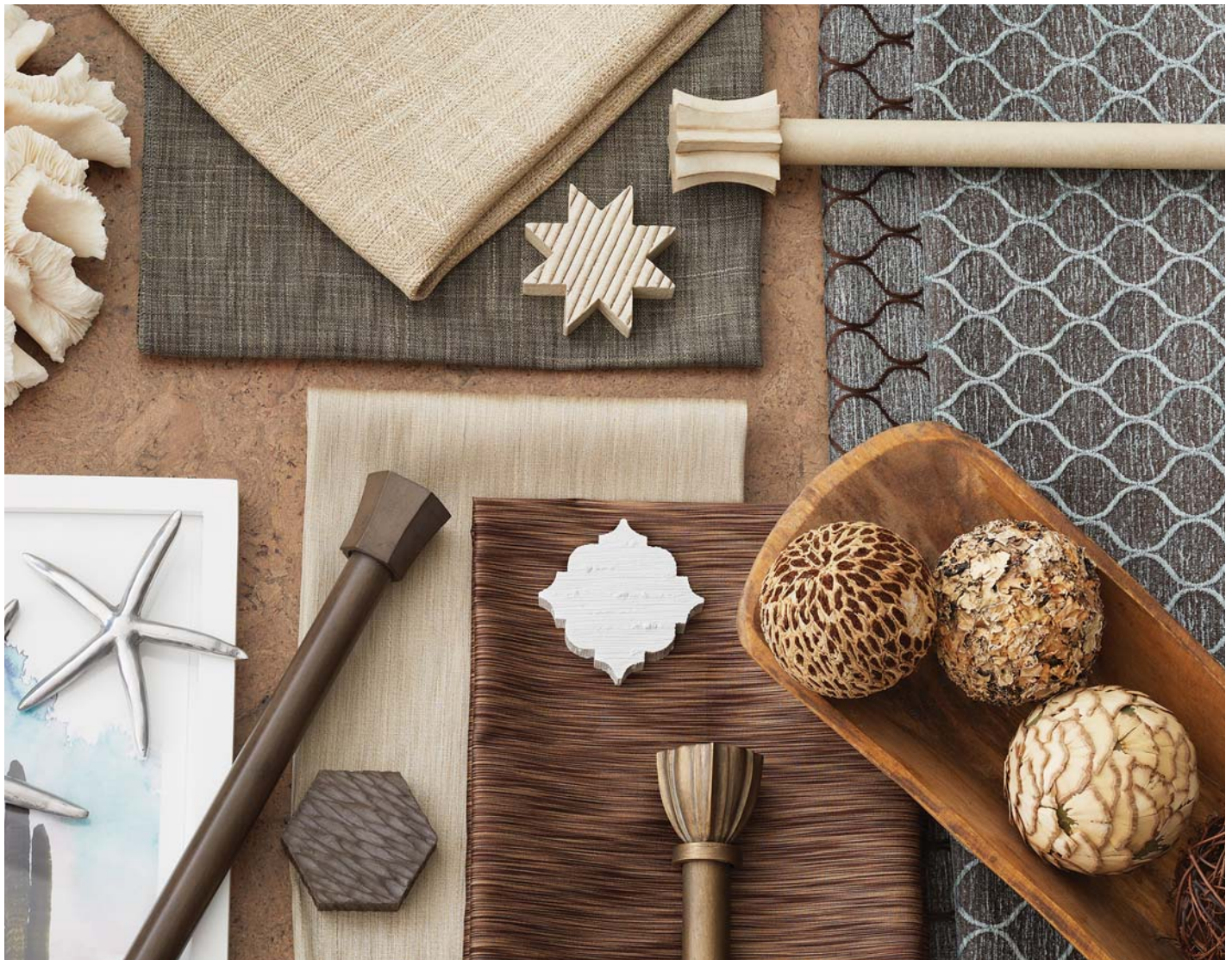

PORTFOLIO 1"



1" Tried & True Resin Finials – *Never go wrong with these timeless classics.*



Paige End Cap
PO100PAEC
1" W
1½" DIA
Silver Maple



Verne
PO100VNFI
1½" W
2" DIA
Timber



Seraphine
PO100SEFI
4½" W
2¾" DIA
Urban Bronze



Celia End Cap
PO100CEEC
1½" W
1½" DIA
Dark Chocolate



Violet
PO100VLF1
3¾" W
2½" DIA
Gossamer



Eleri
PO100ELFI
3¼" W
3½" DIA
Shimmer

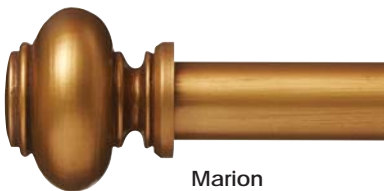

Marion
PO100MAFI
2½" W
2¾" DIA
Antique Gold



Odette
PO100ODFI
2¾" W
1¾" DIA
Urban Bronze



Nicolette
PO100NIFI
3¾" W
2¾" DIA
Spicewood



Keaton
PO100KEFI
2¾" W
2¾" DIA
[1½" square]
Titanium



Clementine
PO100CLFI
2¼" W
2" DIA
Barnwood

1" Finial Accessories & Rings

1" Finial Accessories

1" Finials look great with these accessories.

Verify the compatibility of your chosen Finial and Accessory in the chart below.

Slide these onto your 1" pole for a Glamorous look.

These 1" Bands can be used on a 1" pole in 2 ways:

1. against the base of a 1" finial for a touch of glamour
2. anywhere on the 1" pole for additional decoration



1" Braided Band
PO100BRBAND
5/8" W
1 1/16" ID, 1 5/8" OD
Antique Gold Leaf

- resin; available in any Portfolio Finish
- not recommended for 1" Hand Drawn Traverse System



1" Crystal Band
PO100CRMEBAND
5/8" W
1 1/16" ID, 1 5/8" OD

- metal; available only in dark metal with inlaid crystals
- not recommended for 1" Hand Drawn Traverse System

Add this for a Transitional look or to gain compatibility with the 1" Hand Drawn Traverse System.



1" Cuff
PO100CUFF
3/4" W
1 1/4" DIA
Barnwood

- metal; available in any Portfolio Finish
- covers 5/8" of the pole; finished pole length may need to be increased accordingly

Add this turned element for a Traditional look.



Traditional Collar
POTRADCO
5/8" W
1 1/8" DIA
Titanium

- metal; available in any Portfolio Finish
- must be used with the 1" Cuff
- installs between the Finial and 1" Cuff

1" Modern Metal Finials	•	•		
1" Transitional Metal Finials			(included)	•
1" Textured Metal Finials	•	•	•	
1" Glamour Resin Finials	•	•	•	must use with 1" Cuff, ordered separately
1" Transitional Pearl Resin Finials			(included)	
1" Modern Pearl Resin Finials	•	•		
1" California Resin Finials	•	•	•	
1" Tried and True Resin Finials	•	•	•	

1" Medallion Bands

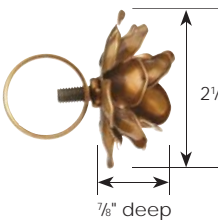

1" Rosaline Medallion Band
POROBAND
Antique Gold
(includes 1" Holdback Medallion Band)



1" Holdback Medallion Band
POMEBAND
3/8" W
1 1/16" ID
1 3/16" OD
Parchment

- Attaches any Holdback Medallion to the front of a 1" pole. Holdback Medallion sold separately. See page 50.

TIP: These two items are also available in Quick Ship Brushed Nickel finish. Refer to Quick Ship Metal 1" Price List for more information.

Common uses for 1" Medallion Bands:

1. repeated decorative embellishment along the length of a pole
2. hold gathered rod pocket drapery panel in place
3. ring stop

1" Rings

Ring Drop indicates distance from bottom of pole to bottom of ring.



Ava Ring
PO100AVRI
1/4" W
1 5/8" H
1 1/4" ID
1 5/8" OD
1/2" drop
Spun Gold



Jacqueline Ring
PO100JARI
3/8" W
1 5/8" H
1 1/4" ID
1 5/8" OD
1/2" drop
Antique Gold



Small C-Ring
PO100SCRI
3/16" W
1 1/2" ID
2" OD
3/4" drop
Gossamer
• use this bypass ring with Gregory Bypass Support Brackets



Swing Ring
PO100SWRI
3/16" W
1 1/2" ID
2" OD
3/4" drop
Antique Gold Leaf

PORTFOLIO 1"

1" Brackets, Poles & Accessories

1" Metal Brackets

Return indicates distance from wall to center of pole.



Laurence 3" Single
PO100LASBK
3/4" W
3 3/4" H backplate
3 1/2" return
Urban Bronze



Cerise Single
PO100CESBK
3 1/8" DIA base
3 1/2" return
Mystic



Laurence 6" Single
PO100LAS6BK
3/4" W
3 3/4" H backplate
6" return
Mink



Cerise Double
PO100CEDBK
3 1/8" DIA base
6 1/2" front return
3 1/2" back return
Both cradles hold
1" diameter pole.
Mystic



Laurence 6" Double
PO100LADBK
3/4" W
3 3/4" H backplate
6" front return
3" back return
Both cradles hold
1" diameter pole.
Mink



1" Metal Ceiling Mount
PO100MCMBK
2" DIA ceiling plate
2 1/4" H
2 1/8" drop (distance
from ceiling to
bottom of pole)
Firelight

Bypass Support Brackets

• Use with Small C Ring



Gregory Single*
PO100GRSBK
3/4" W
3 3/4" H backplate
3 1/2" return
Titanium



Gregory Double*
PO100GRDBK
3/4" W
3 3/4" H backplate
6" front return
3" back return
Both cradles hold
1" diameter pole.
New Age Bronze

*CAUTION: Gregory Brackets do not have full cradles. Self-threading screw installs through bottom of cradle and into 1" pole to secure it. Laurence Brackets must be installed at each end to secure 1" pole.



1" Metal Inside Mount
PO100MIBK
3/4" W
1 1/8" H
1 5/8" D
Gossamer
(Sold in pairs)

Front view when installed.

1" Metal Pole

1" metal poles are sold in 2 foot increments. 2 foot minimum. Poles will be cut to specified lengths. Fall off will not be saved or shipped.

Custom cut metal poles are produced with steel threaded ends.

Maximum continuous length is 16 feet.

Every pole ships with a splicing screw.



Smooth
PO100SM
Firelight

1" Accessories



36" Clear Acrylic Wand
POAC36WAND
1/2" DIA
36" L
Acrylic, clear only

48" Clear Acrylic Wand
POAC48WAND
1/2" DIA
48" L
Acrylic, clear only



41" Metal Wand
POME41WAND
5/8" DIA
41" L
New Age Bronze



1" Hinged Resin Elbow
PO100REL
1 1/8" DIA
3 1/4" overall length
1 1/8" length of each
side when bent
Black

1" Hand Drawn Traverse System

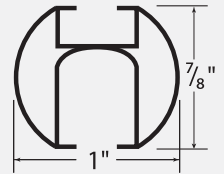

Single 1" Hand Drawn Traverse System
shown in Moonlight Finish;
Elm with Cuff Finial sold separately.



Double 1" Hand Drawn Traverse System
shown in Barnwood Finish;
Cole with Cuff Finial and Luna End Cap
sold separately.



1" Hand Drawn Traverse System RECOMMENDED FOR LIGHTWEIGHT DRAPERIES

1" Hand Drawn Traverse System INCLUDES:

- Track(s): Continuous track available up to 8'; spliced lengths available up to 16'.
- Brackets
- Components: Glides and Glide Stop(s)*
- 48" Clear Acrylic Wand(s)*

**Note: Each Center Draw Track includes 2 Glide Stops and 2 Acrylic Wands. Each One-Way Draw Track includes 1 Glide Stop and 1 Acrylic Wand.*

Finials sold separately.

- 1" Finials with a Cuff must be ordered with all 1" Hand Drawn Traverse Systems.
- Only 1" Transitional Metal Finials and 1" Transitional Pearl Resin Finials can attach to the track without modification. *(Their Cuff is included.)*
- Any 1" Portfolio Finial can be *modified* to fit the 1" Hand Drawn Traverse track with the addition of a 1" Cuff, sold separately.
- Finials must have a Cuff to attach to the track.
- If a Traditional Collar is added to the 1" Transitional Finial or the 1" Glamour Finial with Cuff, it will still fit the track.

Maximum drapery weight - 2 lbs/ft.

Available in any Portfolio Finish.

Order in 3 Easy Steps:

Step 1: Select your Draw.

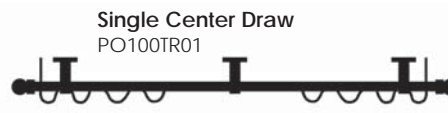

Single Center Draw
PO100TR01



Single One-Way Draw
PO100TR03



Double Center Draw
PO100TR05



Double One-Way Draw
PO100TR07

Step 2: Select your Bracket.

Available Brackets
3½" Single
6" Single
Ceiling Mount

Available Brackets
3½" Single
6" Single
Ceiling Mount

Available Brackets
Double Bracket
Ceiling Mount

Available Brackets
Double Bracket
Ceiling Mount

Step 3: Purchase your Finials, sold separately. See pages 4-12.

To ensure your 1" Portfolio Finial fits the 1" Hand Drawn Traverse Track, a 1" Cuff must be added. (Purchase separately; see page 13.)

Remember: 1" Transitional Metal and 1" Transitional Pearl Resin Finials fit the 1" track without modification – additional Cuff is not necessary.



1" Cuff

PORTFOLIO 1"

INCLUDED IN SYSTEM: 1" Hand Drawn Traverse Brackets

Available in 30 Portfolio finishes. Brackets must be installed every 3-4 feet. Bracket return indicates distance from wall to center of track. See System Quantity Chart below for quantity of brackets included with each system. Additional brackets may be ordered separately.

Bracket style must be specified on your order.



1" Traverse 3 1/2" Single Bracket
PO100TRSBK
2 1/2" DIA backplate
3 1/2" return
Moonlight



1" Traverse 6" Single Bracket
PO100TRS6BK
2 1/8" DIA backplate
6" return
Dark Chocolate



1" Traverse Ceiling Mount Bracket
PO100TRCMBK
2 1/8" DIA ceiling plate
2 1/4" H
2 1/4" return
2 1/2" drop (distance from ceiling to bottom of track)
Firelight



1" Traverse Double Bracket
PO100TRDBK
2 1/8" DIA backplate
6" front return
3" back return
Barnwood

INCLUDED IN SYSTEM: 1" Hand Drawn Traverse Components

Components will be provided in the color that best matches the Portfolio finish, unless otherwise specified. See Component Color Chart below. See System Quantity Chart below for quantity of glides included with each system. Additional components may be ordered separately.

Standard Wheeled Glide

PO100GLIDE
3/8" W
5/8" drop (distance from bottom of track to bottom of eyelet interior when installed)



Bronze
BZ



Champagne
CH



Gold
GO

White Glide may be substituted; please specify on order.



White
WH

Glide Stop

PO100GSTOP
3/8" W
1/4" drop (distance from bottom of track to bottom of eyelet interior when installed)



Bronze
BZ



Champagne
CH



Gold
GO

White Glide Stop may be substituted; please specify on order.



White
WH



Track Splicer
PO100TRSPL

- connects the ends of two tracks
- installs into top channel
- included with all systems over 8'

1" Hand Drawn Traverse System Component Color Chart

Component* Color	Champagne	Bronze	Gold	White
Portfolio Finish	ANDIRON CINNAMON HALO SHIMMER SILVER MAPLE SPUN GOLD STARLET TITANIUM URBAN BRONZE	AMULET ART BRONZE BARNWOOD BLACK DARK CHOCOLATE GOSSAMER JAVA MINK MOONLIGHT NEW AGE BRONZE SPICEWOOD TIMBER	ANTIQUE GOLD ANTIQUE GOLD LEAF ETERNAL FIRELIGHT GOLDENROD MYSTIC	LINEN PARCHMENT WHITE

*White may be substituted
(Must be specified on order.)

Yes

Yes

Yes

-

*Components include Standard Wheeled Glide and Glide Stop.

SYSTEM QUANTITY CHART

Quantity included per set will be based on total system length	Continuous Track Length							Spliced Track Length							
	2'	3'	4'	5'	6'	7'	8'	9'	10'	11'	12'	13'	14'	15'	16'
Glides (4 per foot, includes Glide Stop)	8	12	16	20	24	28	32	36	40	44	48	52	56	60	64
Brackets (1 per every 3-4 feet)	2	2	2	3	3	3	4	4	4	5	5	5	6	6	6



Available in 30 Portfolio finishes (shown on pages 54-55) and unlimited PTH Perfect Match™ finishes (see pages 56-60) .



1¼" Modern Metal Finials

*Remember:
Skye End Cap
covers 7/8" of the
pole. Finished
pole length may
need to be
increased
accordingly.



Skye End Cap*
PO114SKEC
¾" W
1½" DIA
Antique Gold



Ella
PO114ELAFI
1½" W
1½" DIA
Shimmer



Lex
PO114LXFI
1¾" W
2" DIA
Dark Chocolate



Cole
PO114COFI
3¼" W
1½" DIA
Mink



Elm
PO114EMFI
1½" W
2" DIA
Halo



Nora
PO114NOFI
2" W
2¼" DIA
Firelight



Knox - Crystal
PO114KNFI
1¼" W
2¼" DIA
pole shown in Starlet



Elm - Smoke Glass
PO114EMFIGL
1½" W
2" DIA
Urban Bronze



Nora - Mercury Glass
PO114NOFIGL
2½" W
2¾" DIA
Black

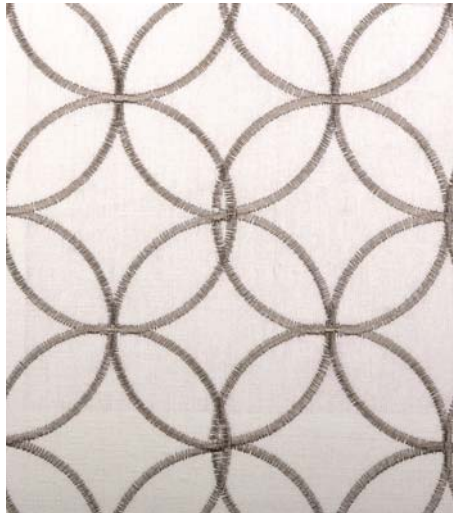

1 1/4" Transitional Metal Finials*

*Remember: Each finial on this page covers 3/8" of the pole. Finished pole length may need to be increased accordingly.



Skye End Cap
PO114SKEC
3/4" W
1 1/2" DIA
Titanium



Ella with Cuff
PO114ELAFICU
2 1/4" W
1 1/8" DIA
Andiron



Lex with Cuff
PO114LXFICU
2 1/2" W
2" DIA
Mystic



Cole with Cuff
PO114COFICU
4" W
1 1/2" DIA
Java



Elm with Cuff
PO114EMFICU
1 7/8" W
2" DIA
Parchment

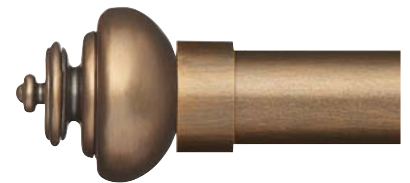

Nora with Cuff
PO114NOFICU
2 3/4" W
2 1/4" DIA
Firelight



Knox - Crystal with Cuff
PO114KNFICU
2" W
2 1/4" DIA
Antique Gold



Elm - Smoke Glass with Cuff
PO114EMFGLCU
1 7/8" W
2" DIA
New Age Bronze

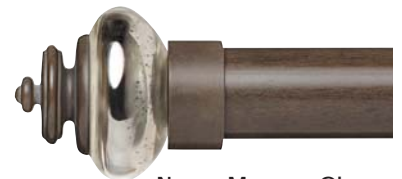

Nora - Mercury Glass with Cuff
PO114NOFGLCU
2 3/8" W
2 3/8" DIA
Barnwood

1 1/4" Transitional Metal Finials look great with a Traditional Collar. MUST BE ORDERED SEPARATELY. SEE PAGE 24.

Lex with Cuff
+
Traditional Collar





1¼" Glamour Resin Finials

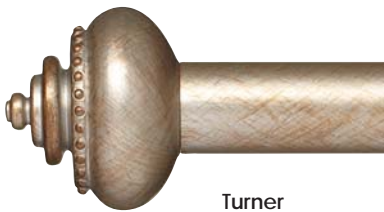

Turner
PO114TUF1
2¼" W
2¾" DIA
Silver Maple



Clara
PO114CLRF1
2¼" W
2½" DIA
Spicewood



Fairbanks
PO114FBF1
3½" W
2" DIA
Mystic



Chaplin
PO114CHF1
1¾" W
2" DIA
Mink



Pickford with Cuff
PO114PIF1CU
3" W
1½" DIA
Urban Bronze
(1¼" Cuff included)



Astor
PO114ASF1
1¾" W
2½" DIA
Shimmer

1¼" Glamour Resin Finials look great with these 1¼" Finial Accessories. MUST BE ORDERED SEPARATELY. SEE PAGE 24.

Astor
+
1¼" Cuff



Astor
+
Traditional Collar
+
1¼" Cuff



1 1/4" Pearl Resin Finials: 3 Pearl Colors. 3 Gorgeous Styles.

1 1/4" Jewel Pearl Resin Finials

Pearl available in white, cream, or grey. Base available in any Portfolio Finish.



White Pearl Jewel
PO114PEJWFI - WH
2 1/4" W
2 3/8" DIA
Base and pole shown in Halo



Cream Pearl Jewel
PO114PEJWFI - CR
2 1/4" W
2 3/8" DIA
Base and pole shown in Halo



Grey Pearl Jewel
PO114PEJWFI - WH
2 1/4" W
2 3/8" DIA
Base and pole shown in Halo

1 1/4" Transitional Pearl Resin Finials

Pearl available in white, cream, or grey. Cuff available in any Portfolio Finish.



White Pearl with Cuff
PO114PEFICU - WH
2 1/4" W
1 5/8" DIA
Cuff and pole shown in Spun Gold



Cream Pearl with Cuff
PO114PEFICU - CR
2 1/4" W
1 5/8" DIA
Cuff and pole shown in Spun Gold



Grey Pearl with Cuff
PO114PEFICU - GY
2 1/4" W
1 5/8" DIA
Cuff and pole shown in Spun Gold

1 1/4" Modern Pearl Resin Finials

Pearl available in white, cream, or grey.



White Pearl
PO114PEFI - WH
1 1/2" W
1 5/8" DIA
pole shown in Dark Chocolate



Cream Pearl
PO114PEFI - CR
1 1/2" W
1 5/8" DIA
pole shown in Dark Chocolate



Grey Pearl
PO114PEFI - GY
1 1/2" W
1 5/8" DIA
pole shown in Dark Chocolate

PORTFOLIO 1 1/4"



To mimic the look of marble, leave your 1 1/4" Baroque Resin Finials unfinished.
Resin Leaf Rings can be found in Portfolio 1 3/8". See page 31.



1 1/4" Baroque Resin Finials



Rachel
PO114RAFI
4" W
3" DIA
Art Bronze



Sebastian
PO114SBFI
2 1/2" W
2 3/4" DIA
Starlet



Sophie
PO114SOFI
3 1/2" W
1 3/4" DIA
Antique Gold Leaf

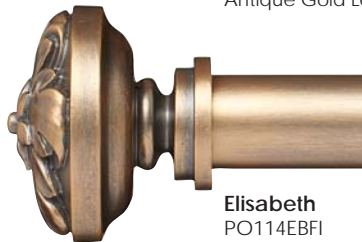

Elisabeth
PO114EBFI
2 1/2" W
3 1/8" DIA
Firelight

1 1/4" Tried & True Resin Finials –
Never go wrong with these timeless classics.



Beale End Cap
PO114BEEC
1/2" W
2" DIA
Eternal



Agnes
PO114AGFI
2" W
2 1/2" DIA
Java



Ruby
PO114RBF1
2 1/2" W
2 1/2" DIA
Halo



Eleanor
PO114ELFI
2 5/8" W
3" DIA
[2 1/8" square]
Mystic

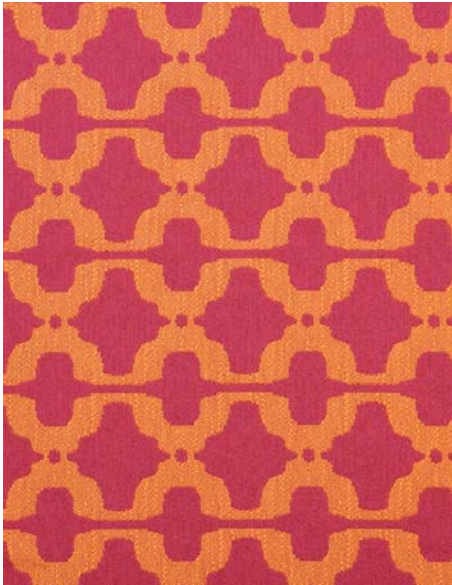

1 1/4" Mid-Century Modern Resin Finials



Fever End Cap
PO114FEEC
1 1/4" W
1 1/8" DIA
New Age Bronze



Shag
PO114SGFI
3 3/4" W
2" DIA
Art Bronze



Shimmy
PO114SHFI
3" W
3 1/2" DIA
Timber



Dazzle
PO114DAFI
5 1/4" W
2 1/2" DIA
Andiron



Rock
PO114ROFI
3 3/4" W
2" DIA
Titanium

1 1/4" Finial Accessories, Brackets, Poles, Rings & Accessories

1 1/4" Finial Accessories

Verify the compatibility of your chosen Finial and Accessory in the chart below.

Add for a Transitional look.



1 1/4" Cuff
PO114CUFF :
3/4" W
1 1/2" DIA
Barnwood

- metal; available in any Portfolio Finish
- covers 5/8" of the pole; finished pole length may need to be increased accordingly

Add for a Traditional look.



Traditional Collar
POTRADCO :
5/8" W
1 1/8" DIA
Titanium

- metal; available in any Portfolio Finish
- must be used with the 1 1/4" Cuff
- installs between the Finial and 1 1/4" Cuff

1 1/4" Transitional Metal Finials	(included)	•
1 1/4" Glamour Resin Finials	•	must use with 1 1/4" Cuff, order separately

1 1/4" Metal Brackets

Return indicates distance from wall to center of pole.



Winston 3" Single
PO114WSSBK
3/4" W
3 3/4" H backplate
3 1/2" return
Spicewood



Winston 6" Single
PO114WSS6BK
3/4" W
3 3/4" H backplate
6" return
Eternal



Winston 6" Double
PO114WSSDBK
3/4" W
3 3/4" H backplate
6" front return
3" back return
Both cradles hold 1 1/4" diameter pole.
Gossamer

Bypass Support Brackets
• Use with Medium C Ring

Gregory Single
PO114GRSBK
3/4" W
3 3/4" H backplate
3 1/2" return
Titanium

Gregory Double
PO114GRDBK
3/4" W
3 3/4" H backplate
6" front return
3" back return
Both cradles hold 1 1/4" diameter pole.
New Age Bronze

*CAUTION: Gregory Brackets do not have full cradles. Self-threading screw installs through bottom of cradle and into 1 1/4" pole to secure it. Winston Brackets must be installed at each end to secure 1 1/4" pole.



1 1/4" Metal Ceiling Mount
PO114MCMBK
2" DIA ceiling plate
2 3/4" H
2 5/8" drop (distance from ceiling to bottom of pole)
Firelight



Front view when installed.

1 1/4" Metal Inside Mount
PO114MIBK
1" W
1 1/4" H
2 1/8" D
Black
(Sold in pairs)

1 1/4" Metal Pole

1 1/4" metal poles are sold in 2 foot increments. 2 foot minimum. Poles will be cut to specified lengths. Fall off will not be saved or shipped.

Custom cut metal poles are produced with steel threaded ends.

Maximum continuous length is 16 feet.

Every pole ships with a splicing screw.



Smooth
PO114SM
Antique Gold Leaf

1 1/4" Accessories



36" Clear Acrylic Wand
POAC36WAND
1/2" DIA
36" L
Acrylic, clear only



41" Metal Wand
POME41WAND
5/8" DIA
41" L
New Age Bronze



48" Clear Acrylic Wand
POAC48WAND
1/2" DIA
48" L
Acrylic, clear only

1 1/4" Rings

Ring Drop indicates distance from bottom of pole to bottom of ring.



Maddox Ring
PO114MARI
3/16" W
2" ID
2 3/8" OD
1" drop
Gossamer



Medium C-Ring
PO114MCRI
3/16" W
2" ID
2 3/8" OD
1" drop
Gossamer
• use this bypass ring with Gregory Bypass Support Brackets



Swing Ring
PO114SWRI
3/16" W
1 1/2" ID
2" OD
1/2" drop
Antique Gold Leaf

1 1/4" Hinged Resin Elbow
PO114REL
1 7/16" DIA
3 3/4" overall length
1 7/8" length of each side when bent
Black





Available in 30 Portfolio finishes (shown on pages 54-55) and unlimited PTH Perfect Match™ finishes (see pages 56-60).



1 3/8" Tried & True Resin Finials – *Never go wrong with these timeless classics.*



Lowell End Cap
PO138LOEC
1" W
1 3/4" DIA
Art Bronze

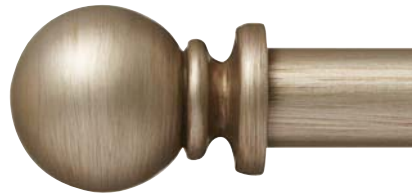

Bradford
PO138BRFI
3 1/4" W
2 1/4" DIA
Titanium



Harper
PO138HAFI
3" W
2 3/4" DIA
Moonlight

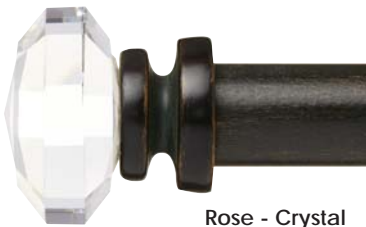

Rose - Crystal
PO138ROFI
2 3/4" W
2 3/4" DIA
Art Bronze



Lillian
PO138LIFI
4" W
3 3/8" DIA
Linen

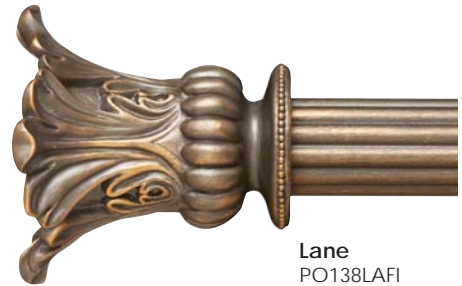

Lane
PO138LAFI
3 1/2" W
3 3/8" DIA
Spun Gold

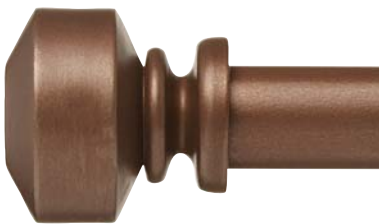

June
PO138JUFI
2 3/4" W
2 3/4" DIA
Cinnamon

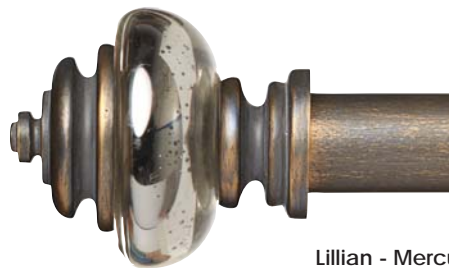

Lillian - Mercury Glass
PO138LIFGL
4" W
3 1/2" DIA
Amulet



Easton
PO138EAFI
2 3/8" W
3 1/2" DIA
Spicewood

1 3/8"



1 3/8" Tried & True Resin Finials – *Never go wrong with these timeless classics.*



Essex End Cap
PO138ESEC
3/4" W
2" DIA
Java



Mae
PO138MAFI
3 1/4" W
2 3/4" DIA
Firelight



Lyla
PO138LYFI
2 5/8" W
2 5/8" DIA
Barnwood

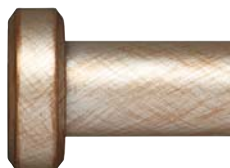

Aubrie End Cap
PO138AUFC
3/4" W
2 1/4" DIA
Silver Maple

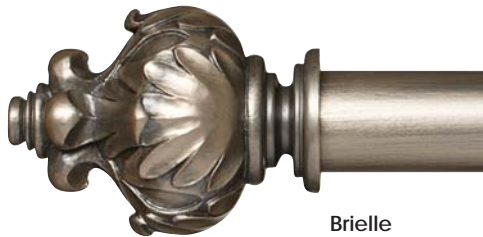

Brielle
PO138BLFI
4" W
3" DIA
Halo



Leo
PO138LEFI
3 5/8" W
2 3/4" DIA
Mink



Jollette
PO138JLFI
1 5/8" W
2 1/4" DIA
Eternal

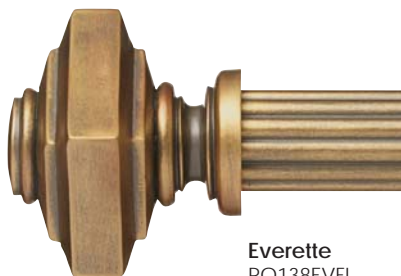

Everette
PO138EVFI
2 7/8" W
3 3/8" DIA
[2 1/2" square]
Urban Bronze



Daphne
PO138DPFI
3 1/4" W
2 1/2" DIA
Titanium



1 3/8" Jewel Resin Finials

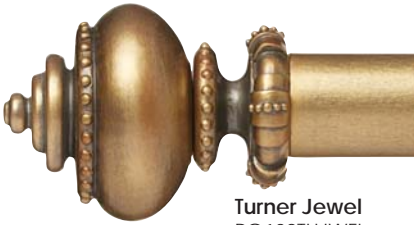

Turner Jewel
PO138TUJWFI
3 1/2" W
2 3/4" DIA
Urban Bronze

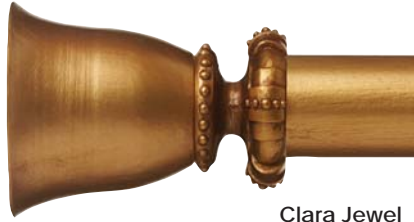

Clara Jewel
PO138CLRJWFI
3 1/2" W
2 5/8" DIA
Antique Gold



Fairbanks Jewel
PO138FBJWFI
4 7/8" W
2 1/8" DIA
Black

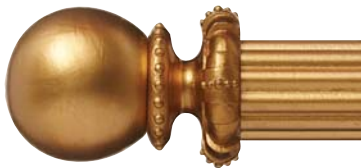

Chaplin Jewel
PO138CHJWFI
3" W
2 1/8" DIA
Goldenrod



Pickford Jewel
PO138PUJWFI
3 1/2" W
2 1/8" DIA
Antique Gold Leaf



Astor Jewel
PO138ASJWFI
2 5/8" W
2 3/8" DIA
Mink



1 3/8" Traditional Resin Finials



Small Carved End Cap
PO138SCEC
7/8" W
1 1/8" DIA
Linen



Avon
PO138AVFI
3 3/8" W
3 3/4" DIA
White



Pierre
PO138PIFI
4 1/2" W
3 3/8" DIA
Moonlight

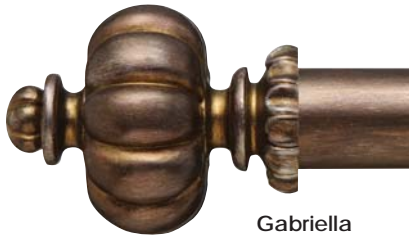

Gabiella
PO138GAFI
3 3/4" W
3" DIA
Shimmer



Severn
PO138SEFI
3 1/2" W
3" DIA
New Age Bronze



Amboise
PO138AMFI
5 1/4" W
3" DIA
Barnwood

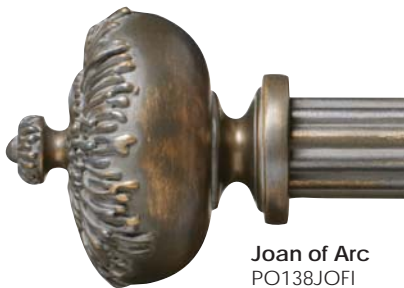

Joan of Arc
PO138JOFI
3 1/2" W
3 3/8" DIA
Amulet



Gaston
PO138GSFI
3 1/2" W
3 3/8" DIA
Parchment



Marcel
PO138MRFI
4 3/4" W
3 3/8" DIA
Halo

1 3/8" Brackets

1 3/8" Metal Brackets

Return indicates distance from wall to center of pole.



Winston 3" Single
PO138WSSBK
3/4" W
3 3/4" H backplate
3 1/2" return
Spicewood



Winston 6" Single
PO138WSS6BK
3/4" W
3 3/4" H backplate
6" return
Mystic



Winston 6" Double
PO138WSDBK
3/4" W
3 3/4" H backplate
6" front return
3" back return
Both cradles hold
1 3/8" diameter pole.
Gossamer

Bypass Support Brackets
• Use with Medium C Ring

Gregory Single
PO138GRSBK
3/4" W
3 3/4" H backplate
3 1/2" return
Gossamer

Gregory Double
PO138GRDBK
3/4" W
3 3/4" H backplate
6" front return
3" back return
Both cradles hold
1 3/8" diameter pole.
New Age Bronze

*CAUTION: Gregory Brackets do not have full cradles. Self-threading screw installs through bottom of cradle and into 1 3/8" pole to secure it. Winston Brackets must be installed at each end to secure 1 3/8" pole.

1 3/8" Resin Brackets

Return indicates distance from wall to center of pole.



William 3" Single
PO138WISBK
1" W
3 1/2" H backplate
3 1/2" return
Spicewood



Edison Single
PO138EDSBK
1" W
4" H backplate
3 3/4" front return
Barnwood



William 6" Single
PO138WIS6BK
1" W
3 1/2" H backplate
6 3/4" return
Firelight



Edison Double
PO138EDDBK
1" W
4" H backplate
6 3/4" front return
3 3/4" back return
Both cradles hold
1 3/8" diameter pole.
Cinnamon



William 6" Double
PO138WIDBK
1" W
3 3/8" H backplate
6 3/4" front return
3 1/4" back return
Both cradles hold
1 3/8" diameter pole.
Mystic



Shelburne
PO138SHBK
1 1/4" W
5 1/4" H
3 3/4" return
Spun Gold



1 3/8" Metal Ceiling Mount
PO138MCMBK
2" DIA ceiling plate
2 3/4" H
2 3/8" drop (distance from ceiling to bottom of pole)
Firelight

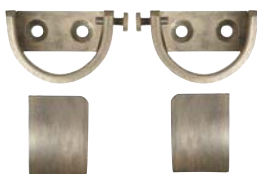

1 3/8" Metal Inside Mount
PO138MIBK
1" W
1 1/4" H
2 1/8" D
Titanium
(Sold in pairs)

Front view when installed.

1 3/8" Wood Brackets



1 3/8" Wood Ceiling Mount
PO138WOCBK
3/4" W
3 1/4" H
6 1/8" D
2 3/8" drop (distance from ceiling to bottom of pole)
Urban Bronze



1 3/8" Wood Inside Mount
PO138WOIBK
1" W
2 3/4" H
2 3/8" D
Urban Bronze
(Sold in pairs)



Grace
PO138GRBK
1 3/8" W
7 3/4" H
3 3/8" return
Java

1 3/8" Poles, Rings & Accessories

1 3/8" Wood Poles

1 3/8" smooth and fluted wood poles are sold in 2 foot increments. 2 foot minimum. Poles will be cut to specified lengths. Fall off will not be saved or shipped.

Maximum continuous length is 12 feet.

Every pole ships with a splicing screw.

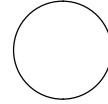

Smooth
PO138SM
Amulet



Fluted
PO138FL
Amulet

1 3/8" Rings

Ring Drop indicates distance from bottom of pole to bottom of ring.



1 3/8" Wood Ring
PO138WRI
1/2" W
1 3/4" ID
2 3/8" OD
3/4" drop
Titanium



1 3/8" Metal Ring
PO138MRI
3/16" W
1 3/4" ID
2 1/4" OD
1/2" drop
Firelight



Leaf Ring
PO138LERI
5/8" W
1 7/8" ID
3 1/8" OD
1 1/4" drop
New Age Bronze



Maddox Ring
PO138MARI
3/16" W
2" ID
2 3/8" OD
3/4" drop
Gossamer



Medium C-Ring
PO138MCRI
3/16" W
2" ID
2 3/8" OD
3/4" drop
Dark Chocolate
• use this bypass ring with Gregory Bypass Support Brackets

1 3/8" Accessories



36" Clear Acrylic Wand
POAC36WAND
1/2" DIA
36" L
Acrylic, clear only

48" Clear Acrylic Wand
POAC48WAND
1/2" DIA
48" L
Acrylic, clear only



41" Metal Wand
POME41WAND
5/8" DIA
41" L
New Age Bronze



1 3/8" Hinged Resin Elbow
PO138REL
1 3/8" DIA
3 3/8" overall length
when bent
1 15/16" length each side
Mink

What's Your Inspiration?

Portfolio 1 3/8" has a style for every window.

Warm
Modern



Aubrie End Cap on smooth pole
Finish: Silver Maple



Transitional
Luxe



Leo Finial on smooth pole
Finish: Mink



Today's
Traditional



Lillian Finial on fluted pole
Finish: Linen



Dark
Glamour



Fairbanks Jewel Finial on fluted pole
Finish: Black



Rustic
Charm

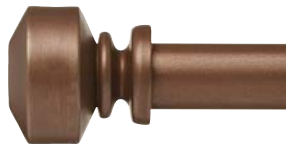

June Finial on smooth pole
Finish: Cinnamon



Bohemian
Chic

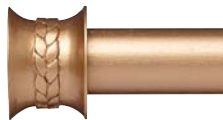

Jollette Finial on smooth pole
Finish: Eternal



Cozy
Cottage



Rose - Crystal Finial on smooth pole
Finish: Art Bronze



Portfolio
2"

Available in 30 Portfolio finishes (shown on pages 54-55) and unlimited PTH Perfect Match™ finishes (see pages 56-60).



2" Glamour Resin Finials



Marin
PO200MNF1
4"W
4 1/8" DIA
Amulet



Sapphire
PO200SAFI
3 1/4"W
3 3/8" DIA
Mystic



Eva
PO200EVFI
5 1/2"W
3 3/4" DIA
Firelight

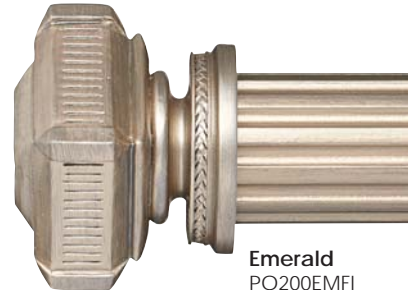

Emerald
PO200EMFI
3"W
3 3/4" DIA
[2 3/4" square]
Halo



Lainey
PO200LAF1
3 3/8"W
3 1/2" DIA
Java



2" Tried & True Resin Finials – *Never go wrong with these timeless classics.*



Cosette End Cap
PO200COEC
1 1/8" W
2 3/4" DIA
Barnwood



Anneliese
PO200AEFI
5" W
4 1/2" DIA
Linen



Nicholas
PO200NIFI
4 1/2" W
3 3/8" DIA
Amulet



Andre
PO200ADFI
3 3/8" W
3 3/8" DIA
Art Bronze



Mariele
PO200MAFI
4 1/4" W
3 1/2" DIA
Dark Chocolate



Madelaine
PO200MDFI
5 3/4" W
3 3/4" DIA
Andiron



2" Tried & True Resin Finials – *Never go wrong with these timeless classics.*



Margot End Cap
PO200MAEC
¾" W
3" DIA
Antique Gold Leaf



Ophelia
PO200OPFI
5¼" W
3⅞" DIA
Urban Bronze

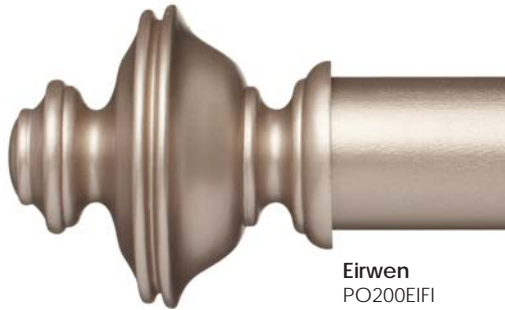

Eirwen
PO200EIFI
4½" W
3¾" DIA
Starlet



Imogene
PO200IMFI
4¾" W
4½" DIA
Moonlight



Cayley
PO200CAFI
3⅞" W
4" DIA
Antique Gold Leaf

2" Brackets

2" Metal Brackets

Return indicates distance from wall to center of pole.



Harlan 3" Single
PO200HASBK
¾" W
3¾" H backplate
4" return
Halo



Camille Single
PO200CMSBK
¾" DIA base
4" return
Moonlight



Harlan 6" Single
PO200HAS6BK
¾" W
3¾" H backplate
6" return
Titanium



Camille Double
PO200CMDBK
¾" DIA base
7" front return
3½" back return
Front cradle holds
2" diameter pole;
back cradle holds
1" diameter pole.
Moonlight



Harlan 6" Double
PO200HADBK
¾" W
3¾" H backplate
6" front return
2¾" back return
Front cradle holds
2" diameter pole;
back cradle holds
1" diameter pole.
Gossamer



2" Metal Ceiling Mount
PO200MCMBK
1" W
3¾" H
3¼" D
3⅝" drop (distance
from ceiling to bottom
of pole)
Dark Chocolate

2" Wood Brackets



2" Wood Ceiling Mount
PO200WOCBK
1" W
4⅞" H
8⅝" D
3⅝" drop (distance from
ceiling to bottom of pole)
Titanium

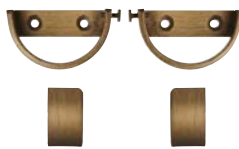

2" Metal Inside Mount
PO200MIBK
1" W
1⅝" H
2⅞" D
Mystic
(Sold in pairs)

Front view when installed.



2" Wood Inside Mount
PO200WOIBK
1" W
3⅞" H
4⅞" D
Linen
(Sold in pairs)

PORTFOLIO 2"

2" Poles, Rings & Accessories

2" Wood Poles

2" smooth and fluted wood poles are sold in 2 foot increments. 2 foot minimum. Poles will be cut to specified lengths. Fall off will not be saved or shipped.

Maximum continuous length is 16 feet.

Every pole ships with a splicing screw.



Smooth
PO200SM
Antique Gold Leaf

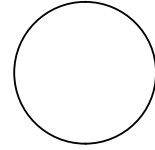

Fluted
PO200FL
Moonlight

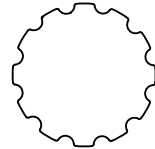

2" Rings

Ring Drop indicates distance from bottom of pole to bottom of ring.



2" Wood Ring
PO200WRI
1/2" W
2 1/4" ID
3 1/4" OD
3/8" drop
Gossamer



Duncan Ring
PO200DURI
3/16" W
2 1/2" ID
2 7/8" OD
3/4" drop
Urban Bronze



Forrest Ring
PO200FORI
3/16" W
2 3/4" ID
3 1/8" OD
1" drop
Titanium



Christelle Ring
PO200CHRI
1/2" W
3 1/4" H
2 1/2" ID
3 7/8" OD
7/8" drop
Antique Gold



Ivanna Ring
PO200IVRI
1/2" W
3 1/4" H
2 1/2" ID
3 1/4" OD
7/8" drop
New Age Bronze

2" Accessories



36" Clear Acrylic Wand
POAC36WAND
1/2" DIA
36" L
Acrylic, clear only

48" Clear Acrylic Wand
POAC48WAND
1/2" DIA
48" L
Acrylic, clear only



41" Metal Wand
POME41WAND
5/8" DIA
41" L
New Age Bronze



2" Hinged Resin Elbow
PO200REL
2 1/16" DIA
4 7/8" overall length
2 3/16" length each
side when bent
Firelight



Available in 30 Portfolio finishes (shown on pages 54-55) and unlimited PTH Perfect Match™ finishes (see pages 56-60).



2¼" Tried & True Resin Finials – *Never go wrong with these timeless classics.*



Brinley End Cap
PO214BREC
1½" W
2¾" DIA
White



Large Carved End Cap
PO214LCEC
1" W
2¾" DIA
Mystic



Gage End Cap
PO214GAEC
1" W
3" DIA
Cinnamon



Stella
PO214STFI
2¼" W
3¼" DIA
Halo



Durham End Cap
PO214DUEC
7⁄8" W
3" DIA
Art Bronze



Edward
PO214EDFI
4¼" W
3¼" DIA
Dark Chocolate



2 1/4" Tried & True Resin Finials – *Never go wrong with these timeless classics.*



Adelaide
PO214ADFI
5"W
3 1/2" DIA
Titanium



Oliver
PO214OLFI
3 3/4" W
3 3/4" DIA
Andiron



Adelaide - Mercury Glass
PO214ADFIGL
5"W
3 3/4" DIA
Mink

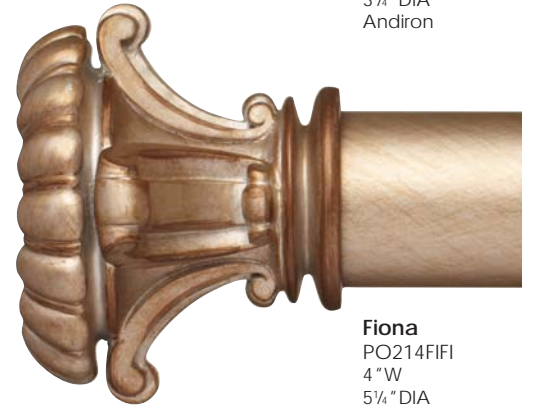

Fiona
PO214FIFI
4"W
5 1/4" DIA
Silver Maple



Hazel - Crystal
PO214HZFI
2 3/4"W
3 1/4" DIA
New Age Bronze



Beatrice
PO214BEFI
4 1/4"W
4" DIA
Amulet

PORTFOLIO 2 1/4"



2 1/4" Glamour Resin Finials



Opal
PO214OPFI
3 1/8" W
3 3/4" DIA
Moonlight



Quincy
PO214QUFI
5 3/4" W
2 3/4" DIA
Cinnamon



Beau
PO214BUFI
4" W
3 3/8" DIA
Spicewood

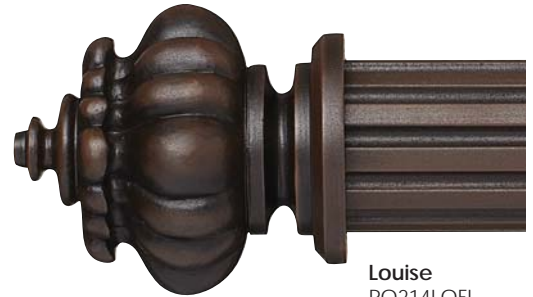

Louise
PO214LOFI
4 1/4" W
4" DIA
Timber

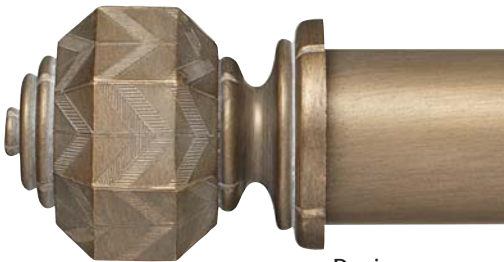

Davies
PO214DAFI
4 1/8" W
3 1/2" DIA
Mystic



Our Flagship Finial

Versailles
PO214VEFI
8" W
3 1/2" H
2 3/4" D
Goldenrod



2 1/4" Glamour Resin Finials



Maribel
PO214MRFI
1 7/8" W
3" DIA
Antique Gold



Sidney
PO214SIFI
3 1/4" W
4 1/4" DIA
[3" square]
Dark Chocolate



Paris
PO214PAFI
2 5/8" W
3 1/2" DIA
Antique Gold Leaf

2 1/4" Traditional Resin Finials

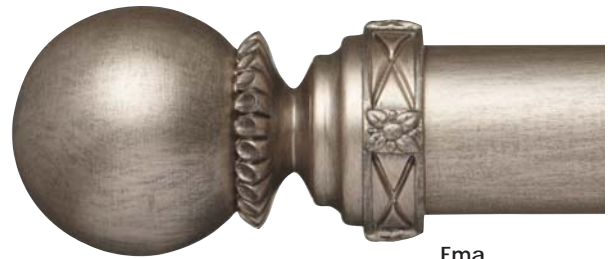

Ema
PO214EAFI
5 1/4" W
3" DIA
Halo



Kenley
PO214KEFI
5 3/4" W
5" DIA
Java



Lyon
PO214LYFI
4 3/4" W
4 7/8" DIA
Firelight

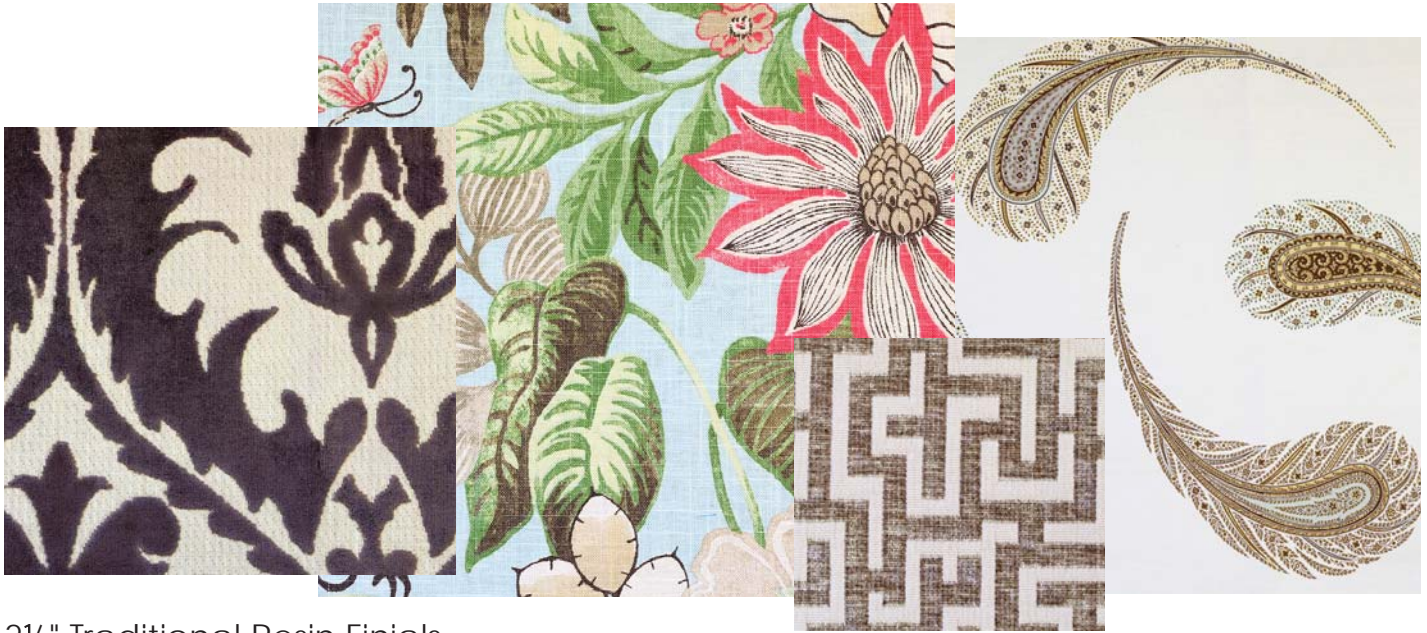

2 1/4" Traditional Resin Finials



Bordeaux
PO214BOFI
4 3/4" W
4 1/8" DIA
Barnwood



Cambria
PO214CMFI
7 1/4" W
4" H
2 3/4" D
Spun Gold

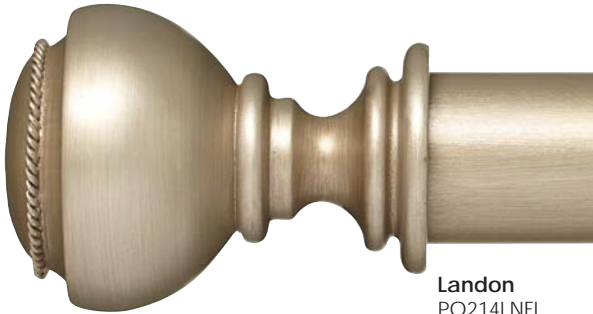

Landon
PO214LNFI
5 1/2" W
4" DIA
Titanium



Rydal
PO214RYFI
5 3/4" W
4 3/8" DIA
Amulet



Greek
PO214GKFI
5" W
4" DIA
Firelight



Artichoke
PO214ARFI
6 3/4" W
3 3/4" DIA
Andrion



2 1/4" Traditional Resin Finials



Natasha
PO214NAFI
4 3/8" W
3 3/4" DIA
Gossamer



Michael
PO214MIFI
6 3/4" W
4" DIA
Shimmer



Marie Antoinette
PO214MAFI
5" W
5" DIA
Antique Gold



Greer
PO214GRFI
7 3/8" W
4 3/4" DIA
Moonlight

2¼" Brackets

2¼" Metal Brackets

Return indicates distance from wall to center of pole.



Harlan 3" Single
PO214HASBK
¾" W
3¾" H backplate
4" return
Halo



Harlan 6" Single
PO214HAS6BK
¾" W
3¾" H backplate
6" return
Titanium



Harlan 6" Double
PO214HADBK
¾" W
3¾" H backplate
6" front return
2½" back return
Front cradle holds 2¼" diameter pole; back cradle holds 1½" diameter pole.
Antique Gold Leaf



2¼" Metal Ceiling Mount
PO214MCMBK
1" W
3¾" H
3¼" D
3½" drop (distance from ceiling to bottom of pole)
Gossamer

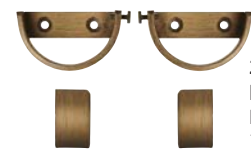

Front view when installed.

2¼" Metal Inside Mount
PO214MIBK
1" W
1½" H
2½" D
Mystic
(Sold in pairs)

2¼" Resin Brackets

Return indicates distance from wall to center of pole.



William 3" Single
PO214WISBK
1" W
4" H backplate
4½" return
Halo



William 6" Single
PO214WIS6BK
1" W
4" H backplate
7½" return
Spicewood



William 6" Double
PO214WIDBK
1" W
3¾" H backplate
7½" front return
3¼" back return
Front cradle holds 2¼" diameter pole; back cradle holds 1½" diameter pole.
Spicewood



Dunmore Single
PO214DUSBK
1" W
4¾" H backplate
4¼" return
Barnwood



Dunmore Double
PO214DUDBK
1" W
4¾" H backplate
7½" front return
3¾" back return
Front cradle holds 2¼" diameter pole; back cradle holds 1½" diameter pole.
Parchment



Preston
PO214PRBK
1½" W
5½" H
4½" return
Mystic



Accessory*
PO214ACBK
1" W
3½" H backplate
4¾" return
Gossamer

*Attach any resin Portfolio Holdback Medallion to the front of this bracket. Holdback Medallions are sold separately. See page 50.

2¼" Wood Brackets



2¼" Wood Ceiling Mount
PO214WOCBK
1" W
4½" H
8¾" D
3½" drop (distance from ceiling to bottom of pole)
Titanium



2¼" Wood Inside Mount
PO214WOIBK
1" W
3½" H
4½" D
Linen
(Sold in pairs)



Lyon
PO214LYBK
1½" W
7½" H backplate
4½" return
Firelight

2 1/4" Poles, Rings & Accessories

2 1/4" Wood Poles

2 1/4" smooth and fluted wood poles are sold in 2 foot increments. 2 foot minimum. Poles will be cut to specified lengths. Fall off will not be saved or shipped.

Maximum continuous length is 16 feet.

Every pole ships with a splicing screw.

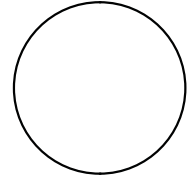

Smooth
PO214SM
Mystic

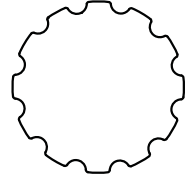

Fluted
PO214FL
Mystic

2 1/4" Rings

Ring Drop indicates distance from bottom of pole to bottom of ring.



2 1/4" Wood Ring
PO214WRI
1/2" W
2 3/8" ID
3 5/8" OD
7/8" drop
Mystic



2 1/4" Metal Ring
PO214MRI
1/4" W
2 1/2" ID
3" OD
1/2" drop
Gossamer



Forrest Ring
PO214FORI
3/16" W
2 3/4" ID
3 1/8" OD
3/4" drop
Titanium



Lyon Ring
PO214LYRI
5/8" W
3" ID
4 1/4" OD
1 3/8" drop
Art Bronze

2 1/4" Accessories



36" Clear Acrylic Wand
POAC36WAND
1/2" DIA
36" L
Acrylic, clear only

48" Clear Acrylic Wand
POAC48WAND
1/2" DIA
48" L
Acrylic, clear only



















41" Metal Wand
POME41WAND
5/8" DIA
41" L
New Age Bronze



2 1/4" Hinged Resin Elbow
PO214REL
2 3/8" DIA
5 1/8" overall length
2 7/16" length each side when bent
Firelight

PORTFOLIO End Cap Chart

End Cap Chart

1"				
	<p>Marcus End Cap PO100MREC ½" W 1½" DIA</p>	<p>Luna End Cap PO100LUEC ¾" W 1½" DIA covers 5/8" of pole</p>	<p>Paige End Cap PO100PAEC 1" W 1½" DIA</p>	<p>Celia End Cap PO100CEEC 1½" W 1½" DIA</p>
1¼"				
	<p>Beale End Cap PO114BEEC ½" W 2" DIA</p>	<p>Skye End Cap PO114SKEC ¾" W 1½" DIA covers 5/8" of pole</p>	<p>Fever End Cap PO114FEEC 1¼" W 1½" DIA</p>	
1¾"				
	<p>Aubrie End Cap PO138AU EC ¾" W 2¼" DIA</p>	<p>Essex End Cap PO138ESE C ¾" W 2" DIA</p>	<p>Small Carved End Cap PO138SCE C ⅞" W 1½" DIA</p>	<p>Lowell End Cap PO138LOEC 1" W 1¾" DIA</p>
2"				
	<p>Margot End Cap PO200MAEC ¾" W 3" DIA</p>	<p>Cosette End Cap PO200COEC 1⅞" W 2¾" DIA</p>		
2¼"				
	<p>Durham End Cap PO214DUEC ⅞" W 3" DIA</p>	<p>Gage End Cap PO214GAEC 1" W 3" DIA</p>	<p>Large Carved End Cap PO214LCEC 1" W 2¾" DIA</p>	<p>Brinley End Cap PO214BRE C 1½" W 2¾" DIA</p>



Portfolio
Holdbacks

Available in 30 Portfolio finishes (shown on pages 54-55) and unlimited PTH Perfect Match™ finishes (see pages 56-60).

PORTFOLIO Holdbacks

Holdback Medallions and Holdback Stems sold separately. Available in any Portfolio finish.

Metal Holdback Medallions – ONLY FIT METAL HOLDBACK STEMS.

Metal Holdback Medallions

Sold in pairs.

Marcus
POMAHB
1 1/2" DIA
1/2" thick
Linen



Jem
POJEHB
2 1/2" DIA
3/8" thick
Black



Achilles
POACHB
2 1/2" square
1/2" thick
Titanium



Blake - Mercury Glass
POBKHB
3" DIA
2 3/8" thick
Barnwood



Mara
POMARHB
3" DIA
7/8" thick
New Age Bronze



Metal Holdback Stems

Sold in pairs.

Projection indicates distance from wall to back of medallion.

Base: 2" DIA
Stem: 1/2" DIA
Firelight
Order 2", 4", or 6" projection:



Don't forget to order your Holdback Stems separately.



Octavia
POOCHB
5 1/2" DIA
1/2" thick
Art Bronze



Larkspur
POLAHB
6" DIA
3/4" thick
Firelight

Resin Holdback Medallions – FIT METAL, RESIN, OR TRADITIONAL RESIN HOLDBACK STEMS.

Resin Holdback Medallions

Sold in pairs.

Clark
POCKHB
3" DIA
1" thick
Mystic



Hustle
POHUHB
3 1/2" DIA
1" thick
Titanium



Laguna
POLGHB
3 1/4" DIA
3/4" thick
Barnwood

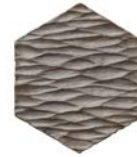

Twirl
POTWHB
3 1/2" DIA
1" thick
Spicewood



Newport
PONEHB
3 1/4" DIA
3/4" thick
Gossamer

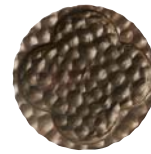

Blois
POBLHB
3 3/4" DIA
3/4" thick
Urban Bronze



Venice
POVEHB
3 1/2" DIA
3/4" thick
Parchment



Chenonceau
POCHHB
3 3/4" DIA
3/4" thick
Shimmer



Sunset
POSUHB
3 1/2" DIA
3/4" thick
Mystic



Brooks
POBRHB
4" DIA
1 1/4" thick
Firelight





Genette
POGEHB
4" DIA
1 1/4" thick
New Age Bronze



Lyon
POLYHB
4 3/4" DIA
2 1/2" thick
Moonlight



Swindon
POSWHB
5 1/8" DIA
1 1/4" thick
Timber



Drake
PODRHB
4 1/2" DIA
1 1/8" thick
Barnwood



Trudy
POTRHB
4 3/4" DIA
3/4" thick
Andiron



Claude
POCLHB
5 1/2" DIA
1" thick
Cinnamon



Bernadette
POBEHB
4 1/2" DIA
1 1/4" thick
Silver Maple



Miranda
POMIHB
5" DIA
1 1/2" thick
Amulet



Isabelle
POISHB
5 1/2" DIA
1 1/4" thick
Art Bronze



Savannah
POSAHB
4 1/2" DIA
3/4" thick
Firelight



Gloria
POGLHB
5" DIA
1 3/8" thick
Mystic



Mirna
POMRHB
4 1/2" DIA
1 1/4" thick
Mink



Braxton
POBXHB
5" DIA
1 1/2" thick
Gossamer

*Don't forget
to order your
Holdback Stems
separately.*

Metal Holdback Stems

Sold in pairs.
Projection indicates distance from wall to back of medallion.

Base: 2" DIA
Stem: 1/2" DIA
Firelight

Order 2", 4", or 6" projection:



POMESTEM2
2" projection



POMESTEM4
4" projection



POMESTEM6
6" projection

Resin Holdback Stems

Sold in pairs.
Projection indicates distance from wall to back of medallion.

Base: 3 1/8" DIA
Stem: 3/4" DIA
Halo

Order 2", 4", or 6" projection:



PORESTEM2
2" projection



PORESTEM4
4" projection



PORESTEM6
6" projection

Traditional Resin Holdback Stems

Sold in pairs.
Projection indicates distance from wall to back of medallion.

Base: 2 1/2" DIA
Stem: 1 1/2" DIA
Barnwood

Order 2", 4", or 6" projection:



POSTEM2
2" projection



POSTEM4
4" projection



POSTEM6
6" projection

PORTFOLIO Holdbacks

Holdback Accessories sold separately. Available in any Portfolio finish.



1" Holdback Medallion Band
 POME BAND
 3/4" W
 1 1/16" ID
 1 3/16" OD
 Parchment



- Attaches any Holdback Medallion to the front of a 1" pole. Holdback Medallion sold separately. See page 50.

Common uses for 1" Medallion Band:

1. repeated decorative embellishment along the length of a pole

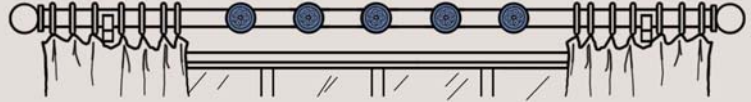

2. hold gathered rod pocket drapery panel in place

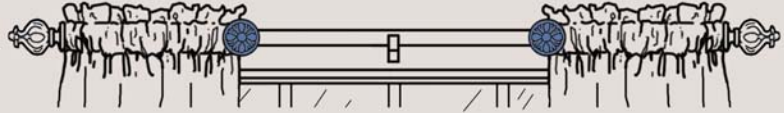

3. ring stop

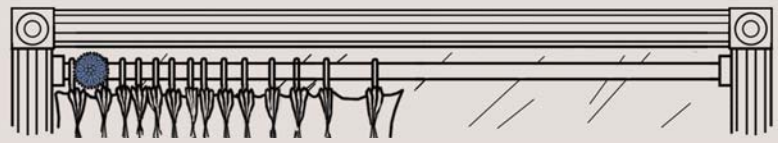

Metal Holdback Arm
 POHBARM
 7" W
 1/2" DIA stem
 1 5/8" H backplate
 5 1/2" deep
 4 1/2" projection
 Black

- Metal Holdback Arms look best with 1" Textured Metal Finials, see pages 6-7.
- May be used with any 1" metal or resin finial without Cuff. Finials are sold separately.



Metal Holdback Arm shown with Hector Finial Mystic



Metal Holdback Arm shown with Achilles Finial Urban Bronze



Portfolio
Finishes

PORTFOLIO Finishes

Photography may not accurately represent the true color of a finish. A finish may show slight variation when painted on different materials, such as wood or steel. For best possible finish match, please refer to the actual sample chip.



TIMBER



SILVER MAPLE



PARCHMENT



TITANIUM



URBAN BRONZE



AMULET



CINNAMON



JAVA



STARLET



NEW AGE BRONZE



FIRELIGHT



SHIMMER



ART BRONZE



MYSTIC



HALO



Photography may not accurately represent the true color of a finish. A finish may show slight variation when painted on different materials, such as wood or steel. For best possible finish match, please refer to the actual sample chip.



ANDIRON



LINEN



SPICEWOOD



DARK CHOCOLATE



ANTIQUÉ GOLD

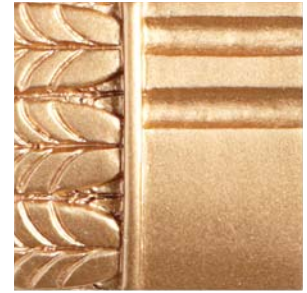

ETERNAL



ANTIQUÉ GOLD LEAF



GOSSAMER



SPUN GOLD

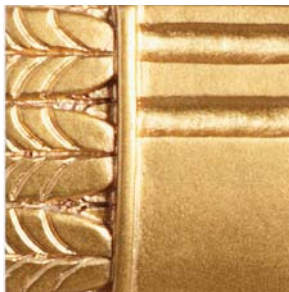

GOLDENROD



BARNWOOD



WHITE



MINK



MOONLIGHT



BLACK

PORTFOLIO Finishes

PTH Perfect Match™



Avon Finial
Million Dollar Red - high-gloss
2003-10
with Gold Highlights



Cayley Finial
Smoke Gray - eggshell
2120-40
with Silver Highlights



Cambria Finial
Hazy Skies - eggshell
OC-48
with Gold Highlights



**Benjamin
Moore®**
Paints

Looking for that perfect hardware finish to match your wall, fabric, or furniture?

Allow PTH Perfect Match™ to stir your imagination and inspire you to create your own unique window treatment.



Imogene Finial
Englewood Cliffs – eggshell
1607



Imogene Finial
Englewood Cliffs – high-gloss
1607

Here's how it works:

Choose any Benjamin Moore® color in either **high-gloss or eggshell** sheen level.

For a minimal service charge, we will apply your specified color to your Paris Texas Hardware selection and responsibly dispose of any leftover paint.

Make it your own:

For a minimal service charge, we will **add highlights** to your PTH Perfect Match™ hardware selections. Highlights are only available on PTH Perfect Match™ finishes.

Choose from 4 highlight options:



(Shown applied to Benjamin Moore® Fuchsine 1343 – eggshell below)



Multiple factors affect the final look of your chosen PTH Perfect Match™ finish:

- High-gloss and eggshell sheen levels affect colors differently. High-gloss sheen tends to deepen your chosen color, causing it to seem slightly darker than it would with an eggshell sheen.
- Smooth and textured surfaces accept highlights in different ways. Products with sculptural relief and texture will receive more noticeable highlights than smooth products.
- Pay attention to the contrast between your chosen Benjamin Moore® color and your chosen highlight. Greater contrast in lightness, brightness, or hue creates a bold highlight. Lower contrast produces a subtle highlight.
- We offer strike-offs to make sure you love your finish and sheen level before you order.

Turn the page to compare various Benjamin Moore® colors with different sheen levels and highlights.

PTH Perfect Match™ HIGHLIGHT COMPARISON CHART

NO HIGHLIGHT

SILVER HIGHLIGHT

Light

EGGSHELL

Cayley Finial, 2" Smooth Pole

Benjamin Moore®
Lavender Mist
2070-60

HIGH-GLOSS

Cayley Finial, 2" Fluted Pole



Bright

EGGSHELL

Ophelia Finial, 2" Smooth Pole

Benjamin Moore®
Fuchsine
1343

HIGH-GLOSS

Ophelia Finial, 2" Fluted Pole

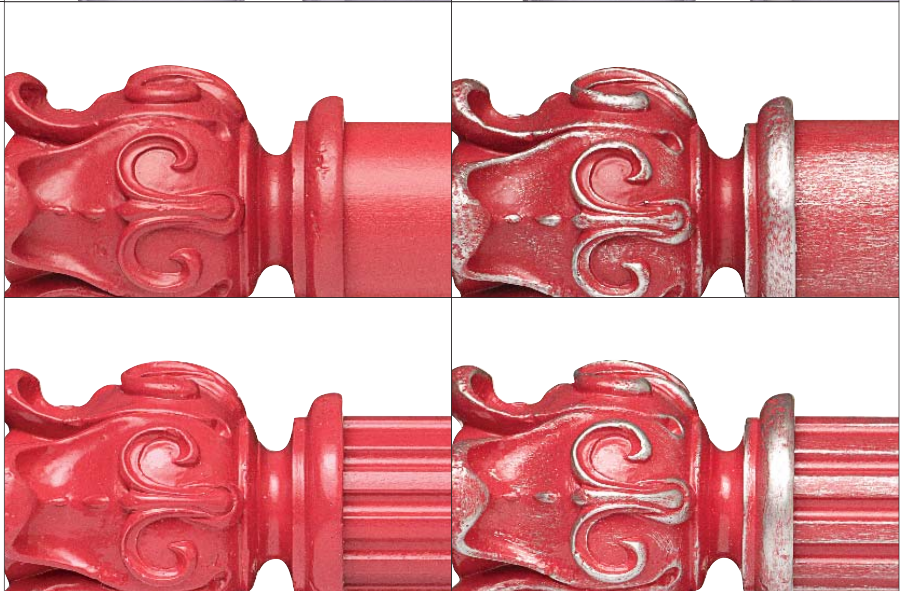

Neutral

EGGSHELL

Imogene Finial, 2" Fluted Pole

Benjamin Moore®
Englewood Cliffs
1607

HIGH-GLOSS

Imogene Finial, 2" Smooth Pole



Note: Glitter is very subtle on light colors and smooth surfaces.

GOLD HIGHLIGHT

ROSE GOLD HIGHLIGHT

GLITTER HIGHLIGHT

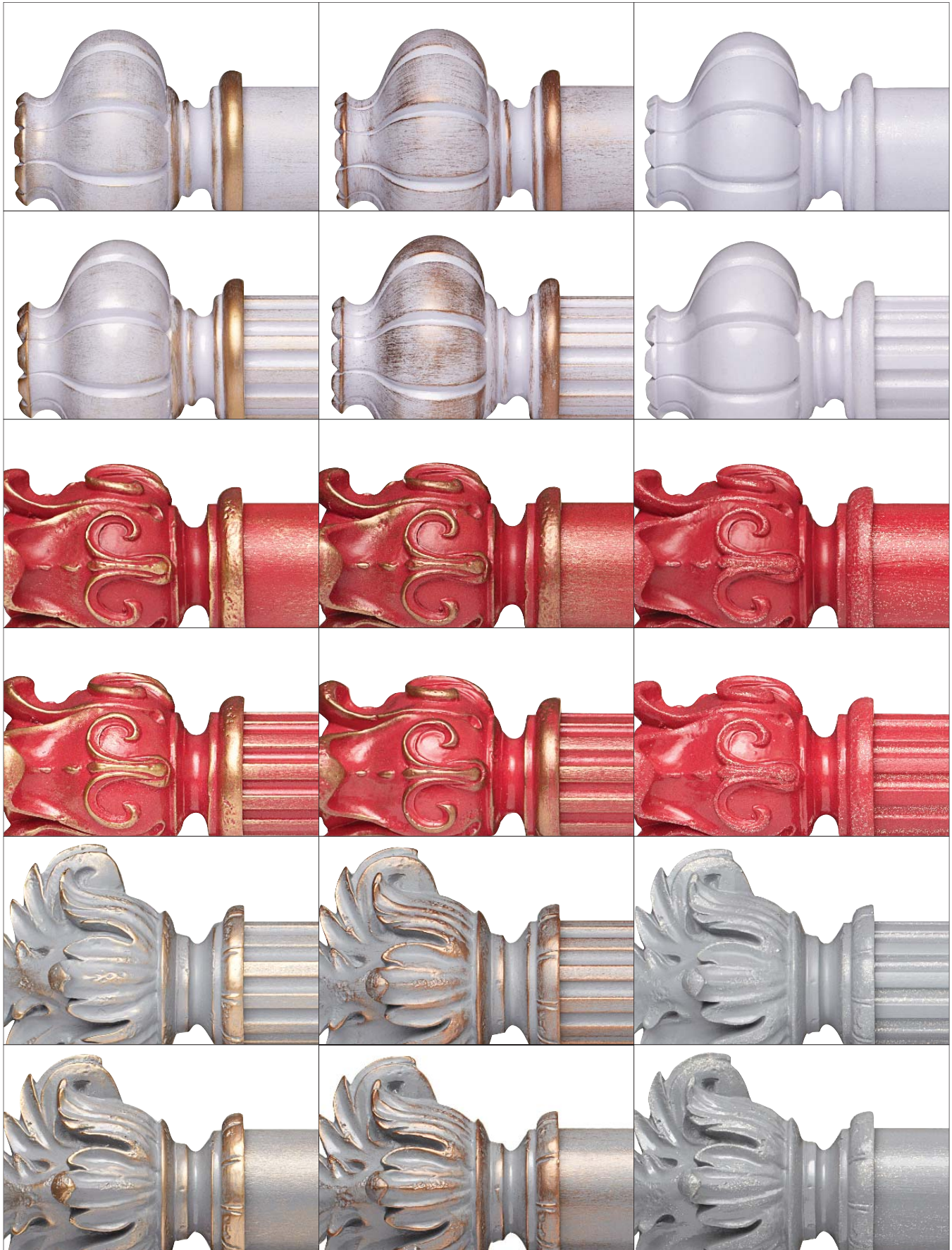

PTH Perfect Match™

Choose any Benjamin Moore® color – and make it your own with highlights – for an unlimited color palette.



Fabrics are a great source of inspiration for your hardware finish.



Adelaide Finial
Mid Summer Night – high-gloss
2134-20
with Gold Highlights



Cambria Finial
Hazy Skies – eggshell
OC-48
with Silver Highlights

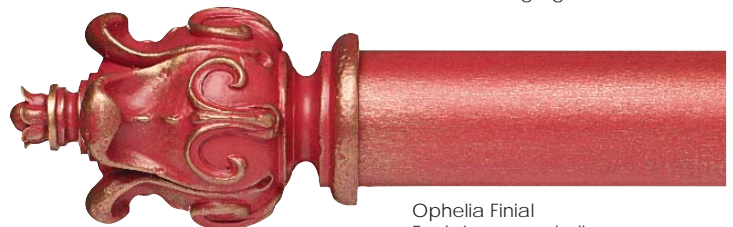

Ophelia Finial
Fuchsine – eggshell
1343
with Rose Gold Highlights

Happy colors make happy kids...

Benjamin Moore® paints brighten nurseries and play rooms.

Little girls' bedrooms are the perfect venue for magical Glitter Highlights.



Venice End Cap
Passion Plum – high-gloss
2073-30

Newport End Cap
Island Sunset – high-gloss
1346



Laguna End Cap
Stratton Blue – eggshell
HC-142



Sunset End Cap
Electric Orange – high-gloss
2015-10

California Finials found on page 10.

Their fun and fresh shapes make them perfect for kids' rooms!



Traverse Systems
Corded & Motorized

Corded & Motorized Traverse

Light-Duty, Standard, and Heavy-Duty Systems

2" and 2¼" wood fascia: smooth and fluted

30 Portfolio custom hand-painted finishes

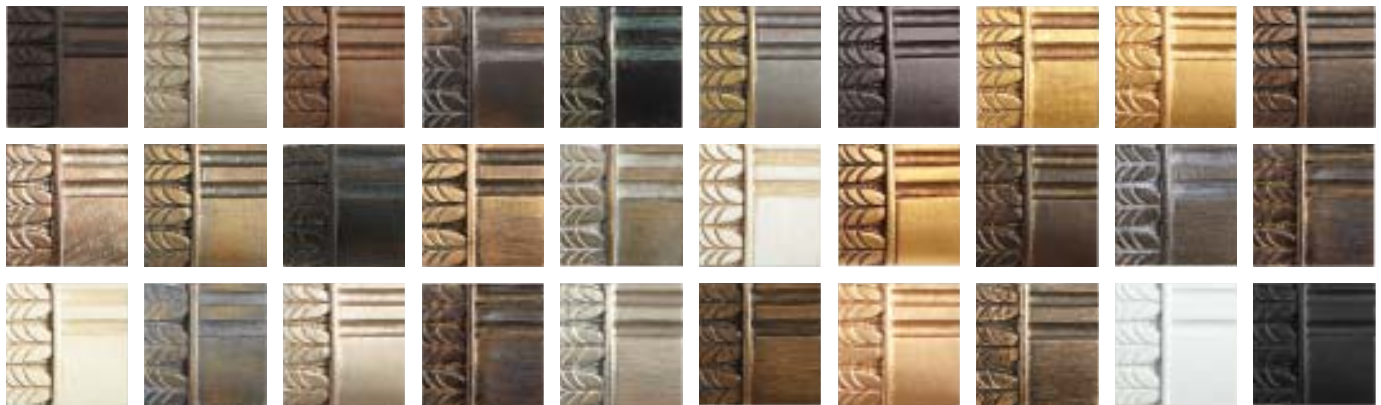

5 Quick Ship Wood and Resin finishes



PTH Perfect Match™:
thousands of Benjamin Moore® colors







10 -15 business day lead time

TRAVERSE SYSTEMS



CORDED AND MOTORIZED TRAVERSE CONFIGURATIONS

(Pictured with EasyPull™ Heavy-Duty Corded Traverse System.)

EasyPull™ Heavy-Duty Traverse pinch pleat	EasyPull™ Light-Duty Traverse pinch pleat	Heavy-Duty Ball Bearing Traverse pinch pleat or Ripplefold® style	BTX DC and Somfy Glydea™ Motorized Traverse pinch pleat or Ripplefold® style	
●	●	●	●	<p>Single Traverse System without Rings</p> 
●				<p>Single Traverse System with Rings</p> 
●	●	●	●	<p>Double Traverse System without Rings</p> 
●				<p>Double Traverse System with Rings</p> 
●	●	●	●	<p>Single or Double System with Mitered Return</p> 
●	●	●	●	<p>Double System with Back Traverse and Stationary Pole in Front</p> 

All traverse systems are available with or without decorative wood fascia.

See Retail Price List for more traverse system details.

TRAVERSE SYSTEMS

EasyPull™ Heavy-Duty Traverse System For Pinch Pleat



System Features:

- Heavy-Duty EasyPull™ System supports up to 8 pounds per foot
- center and one-way draw available
- right or left pull option built-in; no restringing required
- simple pull and release action operates draperies with ease
- continuous track available up to 20'; spliced lengths available up to 38'
- color coordinated track, brackets, and components available in Gold or Bronze
- decorative wood fascia available in 2" or 2 ¼" fluted or smooth profiles
- all Portfolio, Quick Ship Wood and Resin, and PTH Perfect Match™ finishes available

Benefits of EasyPull™ Heavy-Duty Traverse Systems:

- Heavy-Duty System is perfect for heavier treatments
- longer lengths are versatile for residential or commercial projects
- adjustable one cord feature allows user to determine placement of pull cord
- pre-corded with glides and master carriers installed for easy installation; C-rings ship separately and easily snap into glides
- easy to install – track snaps into brackets, fascia clips onto track

How to Order:

1. choose a style

- single or double system
- with or without 2 ¼" C-Rings

2. choose a fascia and finish

- 2" or 2 ¼" fascia
- fluted or smooth profile
- 30 Portfolio finishes
- 5 Quick Ship Wood and Resin finishes
- PTH Perfect Match™

Finials are sold separately. 2" or 2 ¼" Portfolio and Quick Ship Wood and Resin finials are compatible.



Available colors for EasyPull™ Heavy-Duty Traverse System:

Gold

Bronze

See Retail Price List for more traverse system details.

EasyPull™ Light-Duty Basic White Traverse System For Pinch Pleat



System Features:

- Light-Duty Basic White Traverse System supports up to 4 pounds per foot
- center and one-way draw available
- right or left pull option built-in; no restringing required
- simple pull and release action operates draperies with ease
- continuous track available up to 20'; spliced lengths available up to 38'
- track, brackets and components available in White
- decorative wood fascia available in 2" or 2 ¼" fluted or smooth profiles
- all Portfolio, Quick Ship Wood and Resin, and PTH Perfect Match™ finishes available
- not available for use with rings

Benefits of EasyPull™ Light-Duty Traverse Systems:

- Light-Duty Basic White Traverse System is a perfect application for sheers as well as medium weight fabrics
- Light-Duty Basic White Traverse System without fascia is an ideal solution behind cornices and valances
- longer lengths are versatile for residential or commercial projects
- adjustable one cord feature allows user to determine placement of pull cord
- pre-corded for easy installation with glides and master carriers installed
- easy to install – track snaps into brackets, fascia clips onto track

How to Order:

1. choose a style

- single or double system
- without rings only

2. choose a fascia and finish

- 2" or 2 ¼" fascia
- fluted or smooth profile
- 30 Portfolio finishes
- 5 Quick Ship Wood and Resin finishes
- PTH Perfect Match™

Finials are sold separately. 2" or 2 ¼" Portfolio and Quick Ship Wood and Resin finials are compatible.

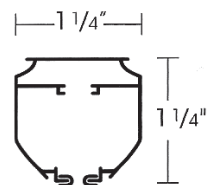

Available color for EasyPull™ Light-Duty Traverse System:

White

See Retail Price List for more traverse system details.

TRAVERSE SYSTEMS

EasyPull™ Traverse Systems Include:



TRACK:



Heavy-Duty Track

- available in Gold or Bronze
- color coordinated to complement fascia finish
- may be ordered with or without wood fascia



Light-Duty Track

- available in White only
- may be ordered with or without wood fascia

BRACKETS: Brackets designed for easy installation – simply snap track into plastic tab on bracket. See Retail Price List for diagrams and specifications.

3" EasyPull™ Single Bracket

EZ50 2 3/8" H x 1 1/8" W backplate

- available in Gold, Bronze, or White
- included in Single Systems

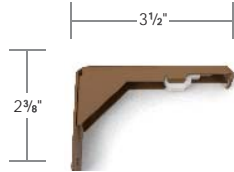

Ceiling Mount Bracket

EZ52 3/8" H x 2 1/2" Deep x 7/8" W

- available in White
- single bracket; may be substituted in Single or Double Systems



6" EasyPull™ Double Bracket

EZ51 2 3/8" H x 1 1/8" W backplate

- available in Gold, Bronze, or White
- included in Double Systems; may be substituted in Single Systems when 6" return is needed

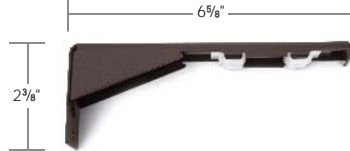

EasyPull™ Over-Bracket

PO214OVBKS 3 1/4" H x 1 1/8" W backplate, 6 7/8" Return

- available in 30 Portfolio, 5 Quick Ship Wood and Resin, and PTH Perfect Match™ finishes
- used to combine 2" or 2 1/4" wood pole with Single Systems
- traverse mounting bracket simply installs under Over-Bracket using the same screws
- matching shims are provided for other traverse brackets



GLIDES: Available for Standard Pinch Pleat Treatments.

No Ring Heavy-Duty EasyPull™ Glide

EZ55

- available in Gold or Bronze
- 3-wheeled glides nest together for a tighter stack-back



2 1/4" C-Ring with Glide

EZ54

- available in Gold or Bronze
- 3-wheeled design allows glides to nest together for a tighter stack-back
- C-Ring available in 30 Portfolio, 5 Quick Ship Wood and Resin, and PTH Perfect Match™ finishes
- ring simply snaps into glide for easy installation
- ring molded from polymer material; will never warp or crack
- only for use with 2 1/4" fascia



No Ring Light-Duty EasyPull™ Glide

EZ59

- available in White
- Light-Duty Basic White glide does not include wheels and creates the tightest stack-back of EasyPull™ systems



Brackets and Glides

quantity per system

Quantity included per set will be based on cut pole length	4'	5'	6'	7'	8'	9'	10'	11'	12'
Glides (including 2 master carriers and 2 end caps)	16	20	24	28	32	36	40	44	48
Brackets (1 per every 3-4 feet)	2	3	3	3	4	4	4	5	5

Note: Glide/Rings count based on 4 per foot

See Retail Price List for more traverse system details.



Heavy-Duty Ball Bearing Traverse System For Pinch Pleat or Ripplefold® style



System Features:

- Heavy-Duty System supports up to 8 lbs/ft
- center and one-way draw available
- right or left cord placement available; must be specified
- Pinch Pleat or Ripplefold® style glides available (80%, 100%, or 120% fullness)
- continuous track available up to 20'; spliced lengths available up to 38' (center draw only)
- color coordinated track and brackets in Gold or Bronze
- glides and pulleys available in White only
- decorative wood fascia available in 2" or 2 ¼" fluted or smooth profiles
- all Portfolio, Quick Ship Wood and Resin, and PTH Perfect Match™ finishes available
- fascia may not be used with ceiling mount system
- not available for use with rings

Benefits of Heavy-Duty Ball Bearing Traverse Systems:

- Heavy-Duty System is recommended for heavier treatments with lining
- ideal solution for treatments mounted over 10' from floor
- longer lengths are versatile for residential or commercial projects

How to Order:

1. choose a style

- single or double system
- without rings only

2. choose a glide

- Standard Pinch Pleat
- Ripplefold® style

3. choose a fascia and finish

- 2" or 2 ¼" fascia
- fluted or smooth profile
- 30 Portfolio finishes
- 5 Quick Ship Wood and Resin finishes
- PTH Perfect Match™

Finials are sold separately. 2" or 2 ¼" Portfolio and Quick Ship Wood and Resin finials are compatible.



Available colors for Heavy-Duty Ball Bearing track and brackets:
Components available in white only.



See Retail Price List for more traverse system details.

TRAVERSE SYSTEMS

Heavy-Duty Ball Bearing Traverse System Includes:

TRACK:



Heavy-Duty Track

- available in Gold, Bronze, or White
- track and brackets color coordinated to complement fascia finish; end pulley and glides in White only
- may be ordered with or without wood fascia

BRACKETS: See Retail Price List for diagrams and specifications.

Single Traverse Brackets

BBTB35 2⁵/₈" H x 1¹/₂" W backplate

- adjustable 3¹/₂" – 4¹/₂" return
- available in Gold, Bronze, and White
- included in Single System



Double Traverse Bracket

BBTB 3³/₈" H x 1¹/₂" W backplate

- adjustable 5¹/₂" – 6¹/₄" front return; adjustable 2¹/₂" – 3¹/₂" back return
- available in Gold, Bronze, and White
- included in Double Systems; may be substituted for Single Systems when 6" return is needed



Single Ceiling Mount Bracket

BBCM 3³/₈" H x 2⁵/₈" Deep x 7¹/₈" W

- available in White
- may only be used in systems without fascia
- single bracket; may be substituted for Single or Double Systems
- for double ceiling mount installation, install two individual bracket clips into ceiling
- ceiling mount bracket clips are also used to attach fascia L-bracket to track



Traverse Fascia L-Bracket

BBLB 1¹/₂" H x 1¹/₂" W

- combines with bracket clip to attach fascia to Ball Bearing Traverse System
- included in system; additional L-Brackets may be ordered separately



Ball Bearing Over-Bracket

BBOVBKS 3¹/₂" H x 3¹/₄" W backplate, 7³/₄" front pole return; 3" back track return

- available in 30 Portfolio, 5 Quick Ship Wood and Resin, and PTH Perfect Match™ finishes
- use to combine 2" or 2¹/₄" full wood pole with Single Traverse Systems
- traverse mounting bracket simply attaches directly into the bottom of the Over-Bracket
- must specify: A. 2" or 2¹/₄" smooth or fluted wood pole
B. back fascia, if desired

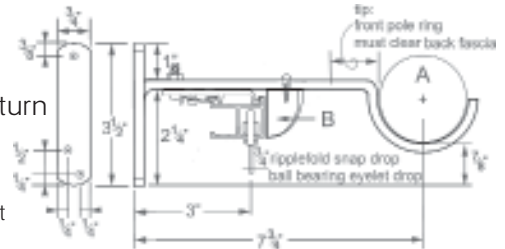

GLIDES: Available for Standard Pinch Pleat or Ripplefold® Style treatments.

No Ring Heavy-Duty Ball Bearing Pinch Pleat Glide

BB55

- available in White



PINCH PLEAT



RIPPLEFOLD® STYLE

Ripplefold® Style Glides

- available in White
- 80%, 100% and 120% fullness available; please specify fullness on order
- overlap master carriers are standard
- butt master carriers available; do not feature overlap, allowing some light to filter between draperies on center draw treatments
- butt master carriers must be specified for substitution

Brackets and Pinch Pleat Carriers

quantity per system

	6'	7'	8'	9'	10'	11'	12'	13'	14'	15'	16'
pinch pleat carriers	24	28	32	36	40	44	48	52	56	60	64
brackets	3	3	4	4	4	5	5	5	6	6	6

Standard carriers are 4 per foot. Standard brackets are 1 every 3-4 feet.

See Retail Price List for more traverse system details.



PTH Motorized Traverse System

For Pinch Pleat or Ripplefold® style

System Features:

- Standard and Heavy-Duty Systems available
- center and one-way draw available
- plug and play power supply for standard wall outlets (110V or 220V AC)
- individual or multi-system control
- wireless wall control available
- manual override and touch control
- Pinch Pleat or Ripplefold® style glides available (80%, 100%, or 120% fullness)
- continuous track available up to 20'; spliced lengths available up to 40'
- decorative wood fascia available in 2" or 2¼" fluted or smooth profiles
- all Portfolio, Quick Ship Wood and Resin, and PTH Perfect Match™ finishes available
- not available for use with rings

BTX DC MOTORIZED TRAVERSE SYSTEM



Shown: 2¼" Smooth Fascia and Fiona Finial in Silver Maple finish, single BTX-DC-60 motorized system, pinch pleat.

- color-coordinated track, brackets, components
- standard 60lb. motor, heavy duty 120lb. motor, and solar powered 45lb. motor available
- tandem motors for increased weight capacity
- standard pinch pleat, Graber® Rollpleat style, or Kirsch Ripplefold® style carriers available
- new Ripplefold® style master carrier allows continuous rippling effect

SOMFY GLYDEA™ RANGE MOTORIZED TRAVERSE SYSTEM



Shown: 2" Smooth Fascia and Mariele Finial in Andiron, single Glydea 35° motorized system, Ripplefold® style, 100% fullness.

- color-coordinated track and brackets: *components are White only*
- standard 77lb. motor or heavy-duty 132lb. motor available
- can integrate with other Somfy motorized products
- *My Position* (set your favorite drapery position)
- standard pinch pleat or Kirsch Ripplefold® style carriers available
- table top control, sun sensor, programmable timer with on-screen display available

Standard colors for BTX and Somfy track and brackets. BTX components available in all three colors. Somfy components available in White only.



Graber is a registered trademark of Springs Window Fashions, Inc. Ripplefold is a registered trademark of Kirsch, Inc.

See Retail Price List for more traverse system details.

TRAVERSE SYSTEMS

Benefits of Motorized Traverse Systems:

- Motorized System is perfect for all treatments – from lightweight sheers to heavily lined fabrics
- ideal solution for treatments mounted where corded systems are not easily reached
- longer lengths are versatile for residential or commercial projects
- network integration available
- ceiling mount systems may be used with or without fascia
- Motorized Systems ship with fascia and brackets installed for easy installation

How to Order:

1. choose a style

- single or double system
- without rings only

2. choose a fascia and finish

- 2" or 2 ¼" fascia
- fluted or smooth profile
- 30 Portfolio finishes
- 5 Quick Ship Wood and Resin finishes
- PTH Perfect Match™

3. choose a motor

- 3 BTX motors
- 2 Somfy Glydea™ motors

4. choose a carrier

- Standard Pinch Pleat
- Ripplefold® style

Finials are sold separately. 2" or 2 ¼" Portfolio and 2 ¼" Quick Ship Wood and Resin finials are compatible.

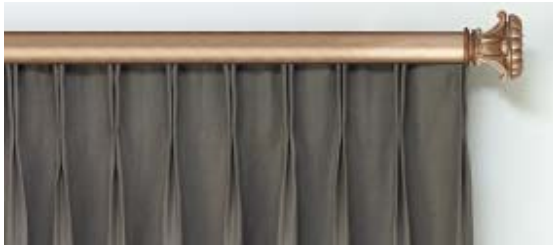

STANDARD PINCH PLEAT

- carriers available in Gold or Bronze or White on BTX System
- carriers available in White only on Somfy System



RIPPLEFOLD® STYLE

- carriers available in White
- 80%, 100% and 120% fullness available; please specify fullness on order

Somfy System:

- overlap master carriers are standard
- butt master carriers available; do not feature overlap, allowing some light to filter between draperies on center draw treatments
- butt master carriers must be specified for substitution

BTX System:

- butt master carriers are standard and feature an underlap arm, allowing continuous rippling effect while also blocking light

Brackets and Pinch Pleat Carriers quantity per system

	6'	7'	8'	9'	10'	11'	12'	13'	14'	15'	16'
pinch pleat carriers	24	28	32	36	40	44	48	52	56	60	64
brackets	3	3	4	4	4	5	5	5	6	6	6

Standard carriers are 4 per foot. Standard brackets are 1 every 3-4 feet.

See Retail Price List for more traverse system details.



Quick Ship

A carefully edited collection of drapery hardware.

And you get it *fast . . .*

Metal 1"

- metal finials you can accessorize
- 1" smooth metal poles *or* 1" Hand Drawn Traverse System
- 5 Quick Ship Metal finishes



Luxe Line

- flat rail Hand Drawn Traverse System
- 3 Luxe Line finishes



Wood and Resin 1 3/8"

- 1 3/8" smooth or fluted wood poles
- 5 Quick Ship Wood and Resin finishes



Wood and Resin 2 1/4"

- 2 1/4" smooth or fluted wood poles
- 5 Quick Ship Wood and Resin finishes



1 business day lead time

Quick Ship
Metal
1"

Quick Ship METAL FINISHES



BRUSHED NICKEL
OSBN



MIDNIGHT
OSMID



ROSE GOLD
OSRG

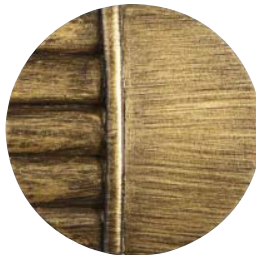

ANTIQUE BRASS
OSAB



OIL RUBBED BRONZE
OSORB

QUICK SHIP Metal 1"> [Orders received by noon CST ship the same day!]

8 classic shapes. 4 gorgeous styles.
Plus, a great little end cap that goes with every style!

Modern

Modern Metal Finials

Located on page 72

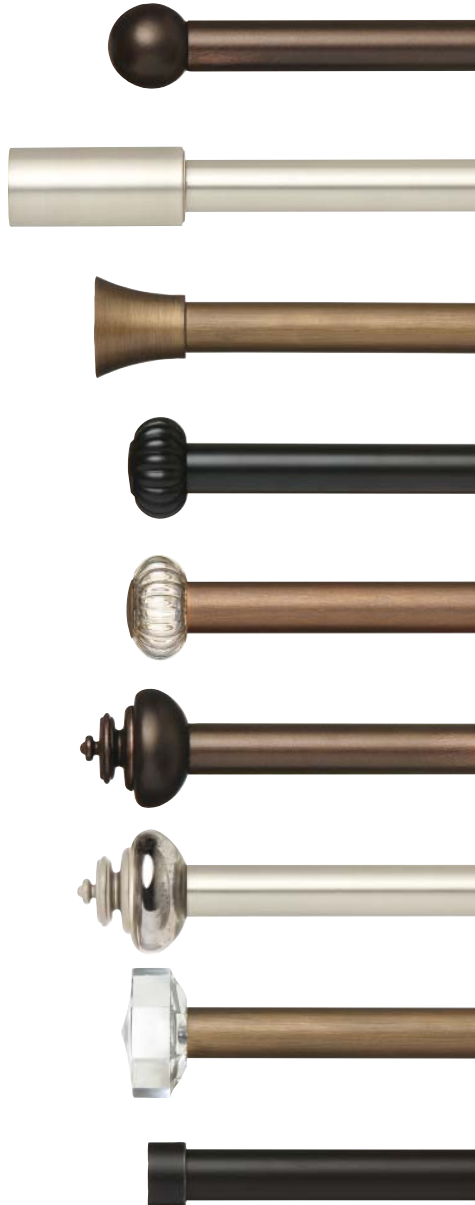

Make It Glamorous!

Add a 1" Crystal Band

Located on page 73



The Modern Metal Finials and the 1" Crystal Band fit the 1" Metal Pole.

The 1" Crystal Band is a Finial Accessory. Position it next to a Modern Metal Finial or anywhere on the 1" Metal Pole for a sparkling treatment.

Oh, and did we mention . . . ?

1" Metal now has a Hand Drawn Traverse track.

Transitional

Transitional Metal Finials

Located on page 74

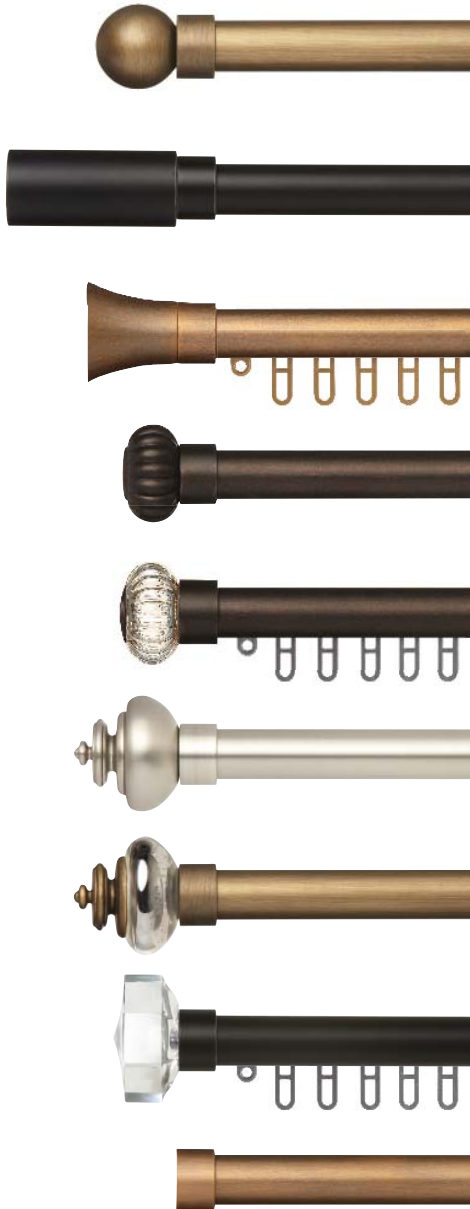

Make It Traditional!

Add a Traditional Collar

Located on page 75

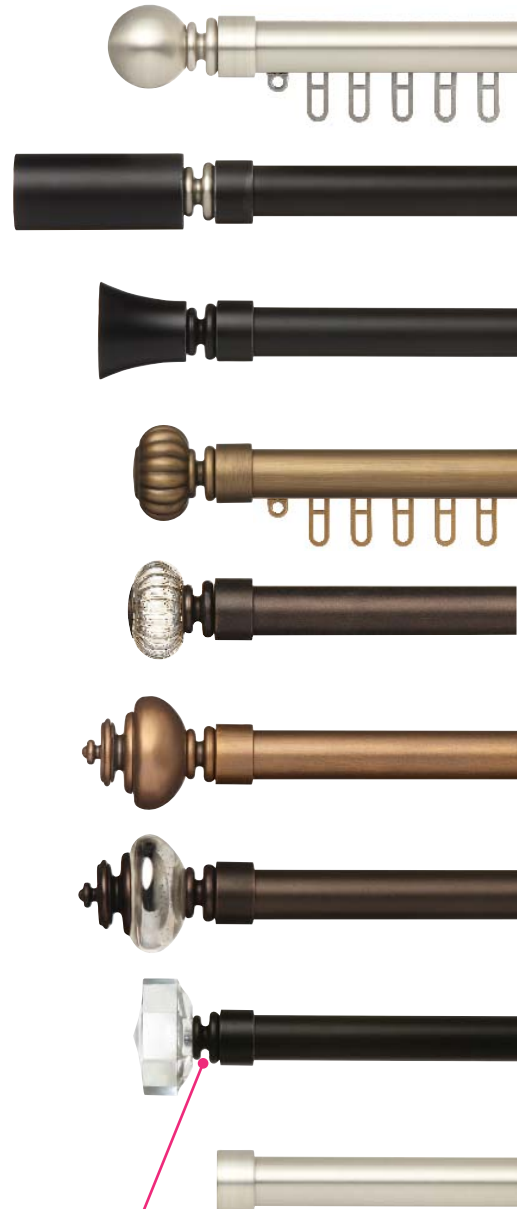

The Transitional Metal Finials fit the 1" Metal Pole and the 1" Hand Drawn Traverse System.

(1" Hand Drawn Traverse System, see pages 78-80.)

The Collar is a Finial Accessory. Add it to the Transitional Metal Finial for a Traditional look.

QUICK SHIP Metal 1"> [Orders received by noon CST ship the same day!]

Modern Metals

Simple designs blend into any contemporary environment.



Lex Finial, Laurence 3" Single Bracket, and 1" Metal Rings shown in Rose Gold

1" Modern Metal Finials *Not compatible with 1" Hand Drawn Traverse System.*

***Remember:**
Luna End Cap covers 3/8" of the pole. Finished pole length may need to be increased accordingly.



Luna End Cap*
QS100LUEC
3/4" W
1 1/4" DIA
Midnight



Ella
QS100ELAFI
1 1/2" W
1 1/2" DIA
Oil Rubbed Bronze



Lex
QS100LXFI
1 3/4" W
2" DIA
Antique Brass



Cole
QS100COFI
3 1/4" W
1 1/2" DIA
Brushed Nickel



Elm
QS100EMFI
1 1/2" W
2" DIA
Midnight



Nora
QS100NOFI
2" W
2 1/4" DIA
Oil Rubbed Bronze



Knox - Crystal
QS100KNFI
1 1/4" W
2 1/4" DIA
pole shown in Antique Brass



Elm - Smoke Glass
QS100EMFIGL
1 1/2" W
2" DIA
Rose Gold



Nora - Mercury Glass
QS100NOFIGL
2 1/8" W
2 3/8" DIA
Brushed Nickel

1" Modern Metal Finials ARE AVAILABLE IN 5 QUICK SHIP METAL FINISHES:



BRUSHED NICKEL
QSNB



MIDNIGHT
QSMID



ROSE GOLD
QSRG



ANTIQU BRASS
QSAB



OIL RUBBED BRONZE
QSORB

Don't forget:
Bling can be
added anywhere
on the pole!

Need Some Glamour?

Dress up your Modern Finial: Add a 1" Crystal Band



1" Crystal Band
QS100CRMEBAND

- 5/8" W
- 1 3/8" DIA
- Metal, only available in dark metal with inlaid crystals.
- Only fits 1" diameter pole.
- Not recommended for 1" Hand Drawn Traverse.

How To Add Your Bling:

1 Buy a pair of 1" Modern Finials.



2 Buy two 1" Crystal Bands.

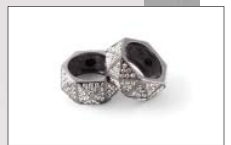

3 Slide each 1" Crystal Band onto the pole before installing finials.



4 Install finials. Slide Crystal Bands against finials and tighten set screws.

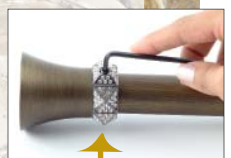

TIP:
1" Crystal Band covers 5/8" of pole!

QUICK SHIP Metal 1" ➔ [Orders received by noon CST ship the same day!]

Transitional Metals

Versatile styling gives you more flexibility.



Elm with Cuff Finial, Laurence 3" Single Bracket, and 1" Metal Rings shown in Oil Rubbed Bronze.

1" Transitional Metal Finials* *Compatible with 1" Hand Drawn Traverse System, see page 78.*

*Remember: Each finial on this page covers 5/8" of the pole. Finished pole length may need to be increased accordingly.



Luna End Cap
 QS100LUEC
 3/4" W
 1 1/4" DIA
 Rose Gold



Ella with Cuff
 QS100ELAFICU
 2 1/4" W
 1 3/8" DIA
 Antique Brass



Lex with Cuff
 QS100LXFICU
 2 1/2" W
 2" DIA
 Rose Gold



Cole with Cuff
 QS100COFICU
 4" W
 1 1/2" DIA
 Midnight



Elm with Cuff
 QS100EMFICU
 1 7/8" W
 2" DIA
 Oil Rubbed Bronze



Nora with Cuff
 QS100NOFICU
 2 3/4" W
 2 1/4" DIA
 Brushed Nickel



Knox - Crystal with Cuff
 QS100KNFICU
 2" W
 2 1/4" DIA
 Midnight



Elm - Smoke Glass with Cuff
 QS100EMFIGLCU
 1 7/8" W
 2" DIA
 Oil Rubbed Bronze



Nora - Mercury Glass with Cuff
 QS100NOFIGLCU
 2 7/8" W
 2 3/8" DIA
 Antique Brass

1" Transitional Metal Finials ARE AVAILABLE IN 5 QUICK SHIP METAL FINISHES:



BRUSHED NICKEL
 QSBN



MIDNIGHT
 QSMID



ROSE GOLD
 QSRG



ANTIQUE BRASS
 QSAB



OIL RUBBED BRONZE
 QSORB

Today's Traditional

Refine your Transitional Finial: Add a Traditional Collar!
(Maintains compatibility with 1" Hand Drawn Traverse.)

TIP:
Traditional Collar
also looks great
in a contrasting
finish like
Brushed Nickel!



Traditional Collar

OSTRADCO

5/8" W

1 1/8" DIA

Brushed Nickel

- Available in any Quick Ship Metal finish.
- Can only be added to Metal Transitional Finials!

How To Make It Traditional:

1 Buy a pair of 1" Transitional Finials.



2 Buy a pair of Traditional Collars.



3 Unscrew the finial from its Cuff.



4 Screw finial into the Traditional Collar. Screw Traditional Collar into the Cuff.



5 Attach the finial to the end of the pole by tightening the set screw on the Cuff.



QUICK SHIP Metal 1" ➔ [Orders received by noon CST ship the same day!]

1" Metal Holdbacks INCLUDE STEMS
(Select 2", 4", or 6" stem projection.)
 Holdback projection indicates distance from wall to back of medallion. Sold in pairs.

Blake - Mercury Glass

3" DIA
 2 3/8" thick
 Rose Gold



2" projection	QSBKHB2
4" projection	QSBKHB4
6" projection	QSBKHB6

Jem

2 1/2" DIA
 3/8" thick
 Midnight



2" projection	QSJEHB2
4" projection	QSJEHB4
6" projection	QSJEHB6

Mara

3" DIA
 7/8" thick
 Oil Rubbed Bronze



2" projection	QSMARHB2
4" projection	QSMARHB4
6" projection	QSMARHB6

Metal Holdback Stems

Base: 2" DIA
 Stem: 1/2" DIA
 Rose Gold

2", 4", or 6" projection must be selected.



2" projection



4" projection



6" projection



1" Metal Holdbacks ARE AVAILABLE IN 5 QUICK SHIP METAL FINISHES:



BRUSHED NICKEL
 QSBN



MIDNIGHT
 QSMID



ROSE GOLD
 QSRG

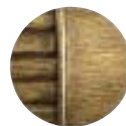

ANTIQUE BRASS
 QSAB



OIL RUBBED BRONZE
 QSORB

1" Metal Brackets, Poles, Rings & Accessories

1" Metal Brackets

Return indicates distance from wall to center of pole.



Laurence 3" Single
 QS100LASBK
 ¾" W
 3¾" H backplate
 3½" return
 Walnut

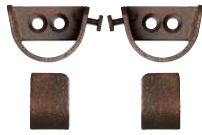

Front view when installed.

1" Metal Inside Mount
 QS100MIBK
 ¾" W
 1½" H
 1½" D
 Oil Rubbed Bronze
 (Sold in pairs)



Laurence 6" Single
 QS100LAS6BK
 ¾" W
 3¾" H backplate
 6" return
 Antique Brass



1" Metal Ceiling Mount
 QS100MCMBK
 2" DIA ceiling plate
 2¼" H
 2½" drop (distance from ceiling to bottom of pole)
 Rose Gold



Laurence 6" Double
 QS100LADBK
 ¾" W
 3¾" H backplate
 6" front return
 3" back return
 Both cradles hold
 1" diameter pole.
 Oil Rubbed Bronze

1" Ring

Ring Drop indicates distance from bottom of pole to bottom of ring.



1" Metal Ring
 QS100MRI
 ¾" W
 1½" ID
 1½" OD
 ¾" drop
 Rose Gold

1" Accessories



36" Clear Acrylic Wand
 QSAC36WAND
 ½" DIA
 36" L
 Acrylic, clear only



48" Clear Acrylic Wand
 QSAC48WAND
 ½" DIA
 48" L
 Acrylic, clear only



1" Hinged Resin Elbow
 QS100REL
 1½" DIA
 3¼" overall length
 1½" length of each side when bent
 Midnight



1" Metal Pole
 QS100SM
 Rose Gold

1" metal poles are sold in 2 foot increments. 2 foot minimum. Poles will be cut to specified lengths. Fall off will not be saved or shipped.

Custom cut metal poles are produced with steel threaded ends.

Maximum continuous length is 12 feet.

Every pole ships with a splicing screw.

Want the 1" Hand Drawn Traverse System instead of a 1" pole?



TURN THE PAGE → → → →

1" Metal Brackets, Poles, Rings & Accessories ARE AVAILABLE IN 5 QUICK SHIP METAL FINISHES:



BRUSHED NICKEL
 QSBN



MIDNIGHT
 QSMID



ROSE GOLD
 QSRG

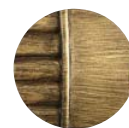

ANTIQUe BRASS
 QSAB



OIL RUBBED BRONZE
 QSORB

QUICK SHIP Metal 1"> [Orders received by noon CST ship the same day!]

1" Hand Drawn Traverse Finials

Transitional

Transitional Metal Finials

Located on page 74

Make It Traditional

Add a Traditional Collar

Located on page 75



1" Transitional Metal Finials and Traditional Collars ARE AVAILABLE IN 5 QUICK SHIP METAL FINISHES:



BRUSHED NICKEL
QSNB



MIDNIGHT
QSMID



ROSE GOLD
QSRG



ANTIQUE BRASS
QSAB



OIL RUBBED BRONZE
QSORB



1" Hand Drawn Traverse System

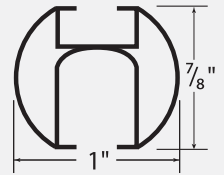

Single 1" Hand Drawn Traverse System
shown in Antique Brass Finish;
Elm with Cuff Finial sold separately.



Double 1" Hand Drawn Traverse System
shown in Brushed Nickel Finish;
Cole with Cuff Finial and Luna End Cap
sold separately.

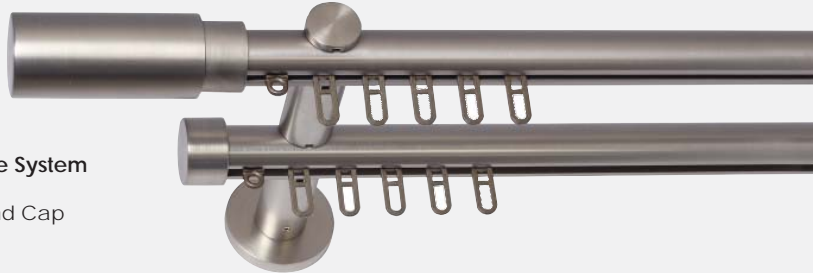

1" Hand Drawn Traverse System RECOMMENDED FOR LIGHTWEIGHT DRAPERIES

1" Hand Drawn Traverse System INCLUDES:

- Track(s): Continuous track available up to 8'; spliced lengths available up to 16'.
- Brackets
- Components: Glides and Glide Stop(s)*
- 48" Clear Acrylic Wand(s)*

**Note: Each Center Draw Track includes 2 Glide Stops and 2 Acrylic Wands. Each One-Way Draw Track includes 1 Glide Stop and 1 Acrylic Wand.*

Finials sold separately.





- Transitional Finials must be ordered with all 1" Hand Drawn Traverse Systems.
- Only 1" Transitional Metal Finials can attach to the track.
- If a Traditional Collar is added to the 1" Transitional Finial, it will still fit the track.

Maximum drapery weight - 2 lbs/ft.

Order in 3 Easy Steps:

Step 1: Select your Draw.

Step 2: Select your Bracket.

<p>Single Center Draw QS100TR01</p> 	<p>Available Brackets 3 1/2" Single 6" Single Ceiling Mount</p>
<p>Single One-Way Draw QS100TR03</p> 	<p>Available Brackets 3 1/2" Single 6" Single Ceiling Mount</p>
<p>Double Center Draw QS100TR05</p> 	<p>Available Brackets Double Bracket Ceiling Mount</p>
<p>Double One-Way Draw QS100TR07</p> 	<p>Available Brackets Double Bracket Ceiling Mount</p>

Step 3: Purchase your Transitional Finials, sold separately. See page 74.

1" Hand Drawn Traverse Systems ARE AVAILABLE IN 5 QUICK SHIP METAL FINISHES:



BRUSHED NICKEL
QSNB



MIDNIGHT
QSMID



ROSE GOLD
QSRG



ANTIQUÉ BRASS
QSNB



OIL RUBBED BRONZE
QSNB

INCLUDED IN SYSTEM: 1" Hand Drawn Traverse Brackets

Available in 5 Quick Ship Metal finishes. Brackets must be installed every 3-4 feet. Bracket return indicates distance from wall to center of track. See System Quantity Chart below for quantity of brackets included with each system. Additional brackets may be ordered separately.

Bracket style must be specified on your order.



1" Traverse 3 1/2" Single Bracket
 QS100TRSBK
 2 1/8" DIA backplate
 3 1/2" return
 Antique Brass



1" Traverse 6" Single Bracket
 QS100TRS6BK
 2 1/8" DIA backplate
 6" return
 Oil Rubbed Bronze



1" Traverse Ceiling Mount Bracket
 QS100TRCMBK
 2 1/8" DIA ceiling plate
 2 1/4" H
 2 3/4" return
 2 1/2" drop (distance from ceiling to bottom of track)
 Rose Gold



1" Traverse Double Bracket
 QS100TRDBK
 2 1/8" DIA backplate
 6" front return
 3" back return
 Brushed Nickel

INCLUDED IN SYSTEM: 1" Hand Drawn Traverse Components

Components will be provided in the color that best matches the Quick Ship Metal finish, unless otherwise specified. See Component Color Chart below. See System Quantity Chart below for quantity of glides included with each system. Additional components may be ordered separately.

Standard Wheeled Glide

QS100GLIDE
 3/8" W
 3/4" drop (distance from bottom of track to bottom of eyelet interior when installed)



Bronze BZ



Champagne CH



Gold GO

White Glide may be substituted; please specify on order.



White WH

Glide Stop anchors the drapery panel at the end of the track.

QS100GSTOP
 3/8" W
 1/4" drop (distance from bottom of track to bottom of eyelet interior when installed)



Bronze BZ



Champagne CH



Gold GO

White Glide Stop may be substituted; please specify on order.



White WH



Track Splicer
 QS100TRSPL
 • connects the ends of two tracks
 • installs into top channel
 • included with all systems over 8'

1" Hand Drawn Traverse System Component Color Chart



BRUSHED NICKEL
 QSBN



MIDNIGHT
 QSMID



ROSE GOLD
 QSRG



ANTIQUE BRASS
 QSAB



OIL RUBBED BRONZE
 QSORB

Component* Color	Champagne	Bronze	Gold	Gold	Bronze
White may be substituted (Must be specified on order.)	Yes	Yes	Yes	Yes	Yes

*Components include Standard Wheeled Glide and Glide Stop.

SYSTEM QUANTITY CHART

Quantity included per set will be based on total system length	Continuous Track Length							Spliced Track Length							
	2'	3'	4'	5'	6'	7'	8'	9'	10'	11'	12'	13'	14'	15'	16'
Glides (4 per foot, includes Glide Stop)	8	12	16	20	24	28	32	36	40	44	48	52	56	60	64
Brackets (1 per every 3-4 feet)	2	2	2	3	3	3	4	4	4	5	5	5	6	6	6

Quick Ship
Luxe Line
Hand Drawn
Traverse System

Quick Ship LUXE LINE FINISHES



BRUSHED NICKEL
OSLXBN



BLACK
OSLXBK



ANTIQUE BRASS
OSLXAB

QUICK SHIP Luxe Line ➔ [Orders received by noon CST ship the same day!]

Luxe Line

Single and Double Systems Available



Single Luxe Line System with Vogue Finial and 3/2" Single Bracket, shown in Brushed Nickel.

Luxe Line Hand Drawn Traverse System RECOMMENDED FOR LIGHTWEIGHT DRAPERIES

Luxe Line Finials only fit Luxe Line Hand Drawn Traverse System. Sold Separately.

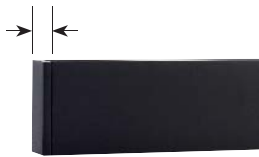

Luxe End Cap
QSLXEC
1/8" W
1 1/4" H
1/2" D
Black



Haute
QSLXHTFI
2 1/8" W
1 1/4" H
1/2" D
Brushed Nickel



Chic
QSLXCHFI
2 3/8" W
1 1/4" H
1/2" D
Antique Brass



Mode
QSLXMOFI
2 1/8" W
1 1/4" H
1/2" D
Brushed Nickel



Vogue
QSLXVOFI
1 7/8" W
1 1/4" H
1/2" D
Antique Brass

*FUN FACT:
These are
the same finial—
just reversed!*

Luxe Line Finials ARE AVAILABLE IN 3 QUICK SHIP LUXE LINE FINISHES:



BRUSHED NICKEL
QSLXBN



BLACK
QSLXBK



ANTIQUÉ BRASS
QSLXAB

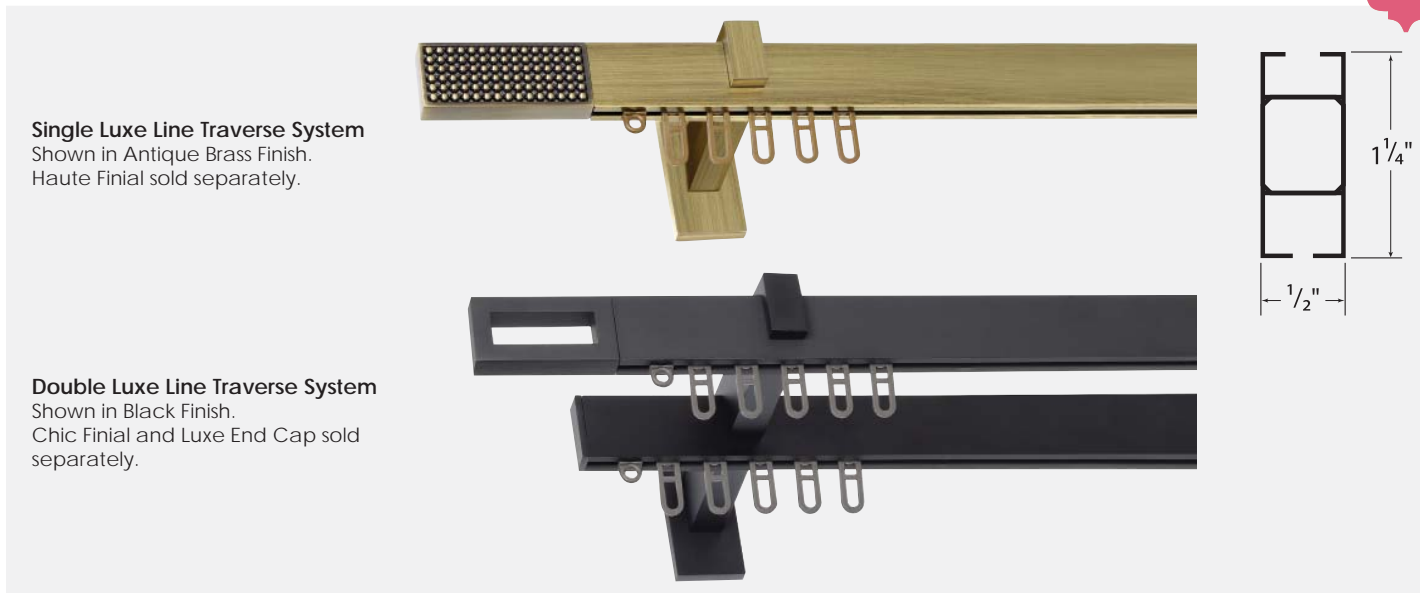

Single Luxe Line Traverse System
Shown in Antique Brass Finish.
Haute Finial sold separately.

Double Luxe Line Traverse System
Shown in Black Finish.
Chic Finial and Luxe End Cap sold separately.

Luxe Line Hand Drawn Traverse System RECOMMENDED FOR LIGHTWEIGHT DRAPERIES

Luxe Line Hand Drawn Traverse System INCLUDES:

- Track(s): Continuous track available up to 8'; spliced lengths available up to 16'.
- Brackets
- Components: Glides and Glide Stop(s)*
- 48" Clear Acrylic Wand(s)*

**Note: Each Center Draw Track includes 2 Glide Stops and 2 Acrylic Wands. Each One-Way Draw Track includes 1 Glide Stop and 1 Acrylic Wand.*

Finials sold separately.

- Luxe Line Finials must be ordered with all Luxe Line Hand Drawn Traverse Systems.
- Only Luxe Line Finials can attach to the track.

Maximum drapery weight - 2 lbs/ft.

Order in 3 Easy Steps:

Step 1: Select your Draw.

Step 2: Select your Bracket.

<p>Single Center Draw QSLX01</p>	<p>Available Brackets 3 1/2" Single 6 1/2" Single Ceiling Mount</p>
<p>Single One-Way Draw QSLX03</p>	<p>Available Brackets 3 1/2" Single 6 1/2" Single Ceiling Mount</p>
<p>Double Center Draw QSLX05</p>	<p>Available Brackets Double Bracket Ceiling Mount</p>
<p>Double One-Way Draw QSLX07</p>	<p>Available Brackets Double Bracket Ceiling Mount</p>

Step 3: Purchase your Luxe Line Finials, sold separately. See page 82.

Luxe Line Hand Drawn Traverse System IS AVAILABLE IN 3 QUICK SHIP LUXE LINE FINISHES:



BRUSHED NICKEL
QSLXBN



BLACK
QSLXBK



ANTIQUE BRASS
QSLXAB

INCLUDED IN SYSTEM: Luxe Line Hand Drawn Traverse Brackets

Available in 3 Quick Ship Luxe Line finishes. Brackets must be installed every 3-4 feet. Bracket return indicates distance from wall to center of track. See System Quantity Chart below for quantity of brackets included with each system. Additional brackets may be ordered separately.

Bracket style must be specified on your order.



Luxe 3 1/2" Single Bracket
 QSLXTRSBK
 2 5/8" H backplate
 1 1/4" W
 3 1/2" return
 Brushed Nickel

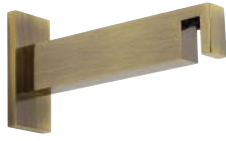

Luxe 6 1/2" Single Bracket
 QSLXTRS6BK
 2 7/8" H backplate
 1 1/4" W
 6 1/2" return
 Antique Brass



Luxe Ceiling Mount Bracket
 QSLXTRCMBK
 2 5/8" H
 2 7/8" W ceiling plate
 1 1/8" return
 3" drop (distance from ceiling to bottom of track)
 Brushed Nickel



Luxe Double Bracket
 QSLXTRDBK
 2 7/8" H backplate
 1 1/4" W
 6 1/2" front return
 3 3/8" back return
 Black

INCLUDED IN SYSTEM: Luxe Line Hand Drawn Traverse Components

Components will be provided in the color that best matches the Quick Ship Luxe Line finish, unless otherwise specified. See Component Color Chart below. See System Quantity Chart below for quantity of glides included with each system. Additional components may be ordered separately.

Standard Wheeled Glide

QSLXGLIDE
 3/8" W
 3/4" drop (distance from bottom of track to bottom of eyelet interior when installed)



Bronze
BZ



Champagne
CH



Gold
GO



White
WH

White Glide may be substituted; please specify on order.

Glide Stop anchors the drapery panel at the end of the track.

QSLXGSTOP
 3/8" W
 1/4" drop (distance from bottom of track to bottom of eyelet interior when installed)



Bronze
BZ



Champagne
CH



Gold
GO

White Glide Stop may be substituted; please specify on order.



White
WH



Track Splicer
 QSLXSPL

- Connects the ends of two tracks
- Installs into top channel
- Included with all systems over 8'

Luxe Line Hand Drawn Traverse System Component Color Chart



BRUSHED NICKEL
 QSLXBN



ANTIQUE BRASS
 QSLXAB



BLACK
 QSLXBK

Component* Color

Champagne

Gold

Bronze

*White may be substituted
 (Must be specified on order.)

Yes

Yes

Yes

*Components include Standard Wheeled Glide and Glide Stop.

SYSTEM QUANTITY CHART

Quantity included per set will be based on total system length	Continuous Track Length							Spliced Track Length							
	2'	3'	4'	5'	6'	7'	8'	9'	10'	11'	12'	13'	14'	15'	16'
Glides (4 per foot, includes Glide Stop)	8	12	16	20	24	28	32	36	40	44	48	52	56	60	64
Brackets (1 per every 3-4 feet)	2	2	2	3	3	3	4	4	4	5	5	5	6	6	6

Quick Ship
Wood and Resin
1³/₈"

Quick Ship WOOD AND RESIN FINISHES



PLATINUM
QSPL



WALNUT
QSWAL



ROSE GOLD
QSRG



ANTIQUE BRASS
QSAB



OIL RUBBED BRONZE
QSORB

Moderate Size. Big Statement.

With poles small enough for a rod pocket and finials that make a BIG statement, 1 3/8" may be your perfect size.



Lillian - Mercury Glass Finial shown in Platinum.

1 3/8" Resin Finials



Lowell End Cap
 QS138LOEC
 1" W
 1 3/4" DIA
 Walnut



Bradford
 QS138BRFI
 3 1/4" W
 2 1/4" DIA
 Walnut



Harper
 QS138HAFI
 3" W
 2 1/4" DIA
 Platinum



Rose - Crystal
 QS138ROFI
 2 3/4" W
 2 3/4" DIA
 Antique Brass

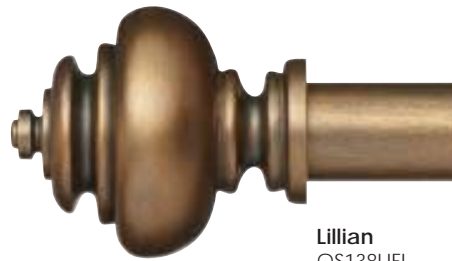

Lillian
 QS138LIFI
 4" W
 3 3/8" DIA
 Rose Gold



Lane
 QS138LAFI
 3 1/2" W
 3 3/8" DIA
 Rose Gold



June
 QS138JUFI
 2 3/4" W
 2 3/4" DIA
 Oil Rubbed Bronze



Lillian - Mercury Glass
 QS138LIFIGL
 4" W
 3 1/2" DIA
 Platinum



Easton
 QS138EAFI
 2 3/8" W
 3 1/2" DIA
 Oil Rubbed Bronze

Quick Ship Finishes work beautifully with natural materials and earthy textures.

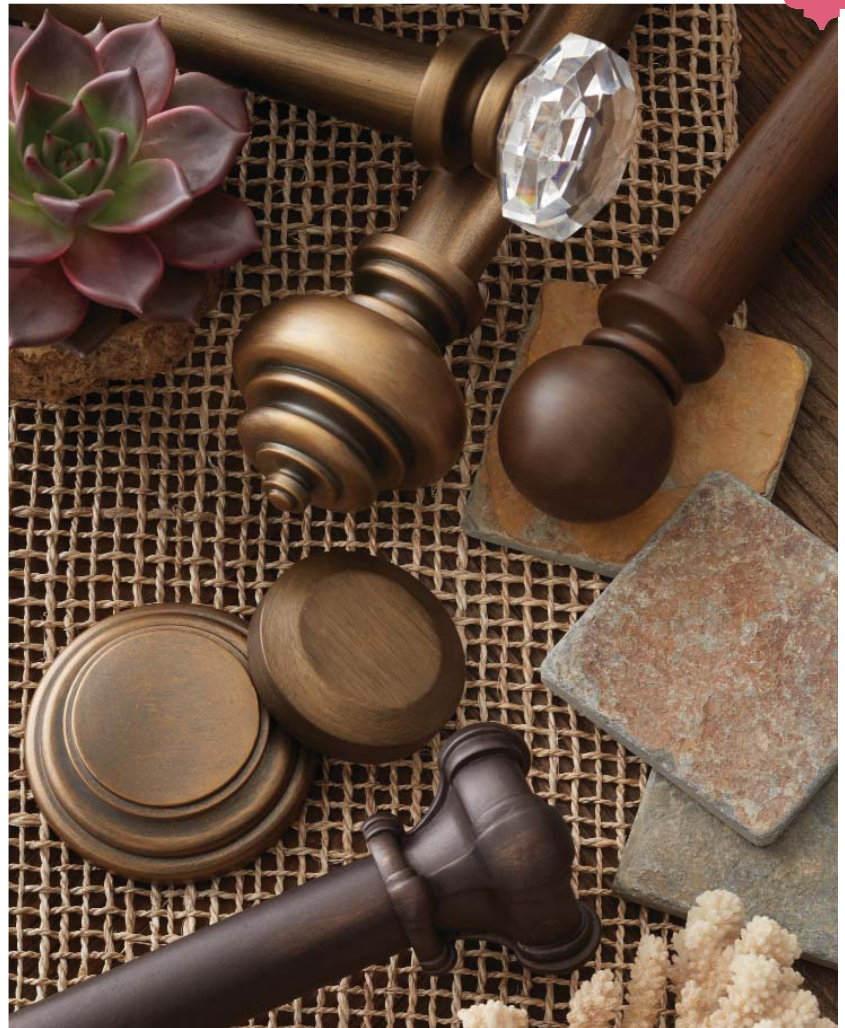

1 3/8" Holdbacks INCLUDE STEMS

(Select 2", 4", or 6" stem projection.)

Holdback projection indicates distance from wall to back of medallion. Sold in pairs.

Metal Holdbacks include Metal Holdback Stems

Blake - Mercury Glass
3" DIA
2 5/8" thick
Rose Gold



2" projection	QSBKHB2
4" projection	QSBKHB4
6" projection	QSBKHB6

Metal Holdback Stems

Base: 2" DIA
Stem: 1/2" DIA
Rose Gold

2", 4", or 6" projection must be selected.

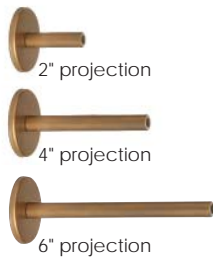

Resin Holdbacks include Resin Holdback Stems

Clark
3" DIA
1" thick
Antique Brass



2" projection	QSCKHB2
4" projection	QSCKHB4
6" projection	QSCKHB6

Trudy
4 3/4" DIA
3/4" thick
Walnut



2" projection	QSTRHB2
4" projection	QSTRHB4
6" projection	QSTRHB6

Brooks
4" DIA
1 1/4" thick
Rose Gold



2" projection	QSBRHB2
4" projection	QSBRHB4
6" projection	QSBRHB6

Miranda
5" DIA
1 1/2" thick
Platinum



2" projection	QSMIHB2
4" projection	QSMIHB4
6" projection	QSMIHB6

Resin Holdback Stems

Base: 3 1/2" DIA
Stem: 3/4" DIA
Platinum

2", 4", or 6" projection must be selected.



1 3/8" Finials & Holdbacks ARE AVAILABLE IN 5 QUICK SHIP WOOD AND RESIN FINISHES:



PLATINUM
QSPL



WALNUT
QSWAL



ROSE GOLD
QSRG



ANTIQUÉ BRASS
QSAB



OIL RUBBED BRONZE
QSORB

1 3/8" Brackets, Poles, Rings & Accessories

1 3/8" Metal Brackets

Return indicates distance from wall to center of pole.



Winston 3" Single
 QS138WSSBK
 3/4" W
 3 3/4" H backplate
 3 1/2" return
 Walnut



Winston 6" Single
 QS138WSS6BK
 3/4" W
 3 3/4" H backplate
 6" return
 Antique Brass



Winston 6" Double
 QS138WSDBK
 3/4" W
 3 3/4" H backplate
 6" front return
 3" back return
 Both cradles hold
 1 3/8" diameter pole.
 Oil Rubbed Bronze

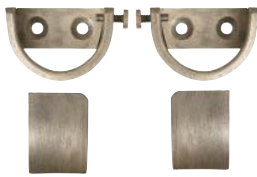

1 3/8" Metal Inside Mount
 QS138MIBK
 1" W
 1 1/4" H
 2 1/8" D
 Platinum
 (Sold in pairs)

Front view when installed.



1 3/8" Metal Ceiling Mount
 QS138MCMBK
 2" DIA ceiling plate
 2 3/4" H
 2 5/8" drop (distance from ceiling to bottom of pole)
 Rose Gold

1 3/8" Resin Brackets

Return indicates distance from wall to center of pole.



William 3" Single
 QS138WISBK
 1" W
 3 1/2" H backplate
 3 3/4" return
 Walnut



William 6" Single
 QS138WIS6BK
 1" W
 3 1/2" H backplate
 6 3/4" return
 Rose Gold



William 6" Double
 QS138WIDBK
 1" W
 3 3/4" H backplate
 6 3/4" front return
 3 1/2" back return
 Both cradles hold
 1 3/8" diameter pole.
 Antique Brass

1 3/8" Rings

Drop indicates distance from bottom of pole to bottom of ring.



1 3/8" Wood Ring
 QS138WRI
 1/2" W
 1 3/4" ID
 2 5/8" OD
 3/4" drop
 Platinum



1 3/8" Metal Ring
 QS138MRI
 3/16" W
 1 3/4" ID
 2 1/4" OD
 1/2" drop
 Rose Gold

1 3/8" Accessories



36" Clear Acrylic Wand
 QSAC36WAND
 1/2" DIA
 36" L
 Acrylic, clear only



48" Clear Acrylic Wand
 QSAC48WAND
 1/2" DIA
 48" L
 Acrylic, clear only



1 3/8" Hinged Resin Elbow
 QS138REL
 1 5/8" DIA
 3 7/8" overall length
 1 15/16" length each side when bent
 Oil Rubbed Bronze

1 3/8" Wood Poles



Smooth
 QS138SM
 Rose Gold



Fluted
 QS138FL
 Rose Gold

1 3/8" smooth and fluted wood poles are sold in 2 foot increments. 2 foot minimum. Poles will be cut to specified lengths. Fall off will not be saved or shipped.

Maximum continuous length is 12 feet.
 Every pole ships with a splicing screw.

1 3/8" Brackets, Poles, Rings & Accessories ARE AVAILABLE IN 5 QUICK SHIP WOOD AND RESIN FINISHES:



PLATINUM
 QSPL



WALNUT
 OSWAL



ROSE GOLD
 OSRG



ANTIQUe BRASS
 OSAB



OIL RUBBED BRONZE
 OSORB

Quick Ship
Wood and Resin
2 1/4"

Quick Ship WOOD AND RESIN FINISHES



PLATINUM
QSPL



WALNUT
QSWAL



ROSE GOLD
QSRG



ANTIQUE BRASS
QSAB



OIL RUBBED BRONZE
QSORB

Large Scale. Fine Details.

With an update on tradition and an upgrade in size, 2 1/4" adds sophistication to any window.



Beatrice Resin Finial, William 3/2 Single Bracket, and Wood Rings shown in Walnut.

2 1/4" Resin Finials



Brinley End Cap
 QS214BREC
 1 1/2" W
 2 3/4" DIA
 Antique Brass

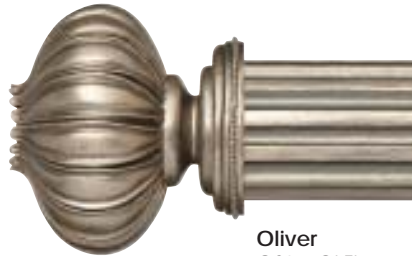

Oliver
 QS214OLFI
 3 3/4" W
 3 3/4" DIA
 Platinum

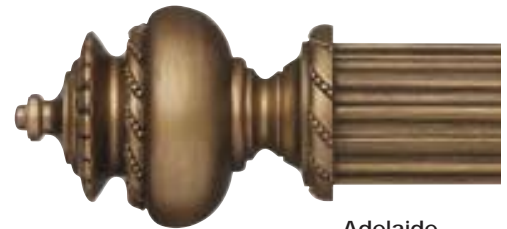

Adelaide
 QS214ADFI
 5" W
 3 1/2" DIA
 Antique Brass



Hazel - Crystal
 QS214HZFI
 2 3/4" W
 3 1/4" DIA
 Walnut



Fiona
 QS214FIFI
 4" W
 5 1/4" DIA
 Oil Rubbed Bronze

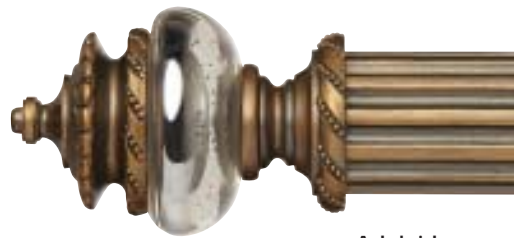

Adelaide - Mercury Glass
 QS214ADFIGL
 5" W
 3 3/8" DIA
 Rose Gold



Stella
 QS214STFI
 2 1/4" W
 3 1/4" DIA
 Platinum



Beatrice
 QS214BEFI
 4 1/4" W
 4" DIA
 Walnut



Edward
 QS214EDFI
 4 1/4" W
 3 1/4" DIA
 Oil Rubbed Bronze

*Elegant and dramatic,
large scale finials provide
instant distinction
to any window.*

2 1/4" Holdbacks INCLUDE STEMS

(Select 2", 4", or 6" stem projection.)

Holdback projection indicates distance from wall to back of medallion. Sold in pairs.

Metal Holdbacks include Metal Holdback Stems

**Blake -
Mercury Glass**

3" DIA
2 5/8" thick
Rose Gold



2" projection	QSBKHB2
4" projection	QSBKHB4
6" projection	QSBKHB6

Metal Holdback Stems

Base: 2" DIA
Stem: 1/2" DIA
Rose Gold

2", 4", or 6" projection
must be selected.

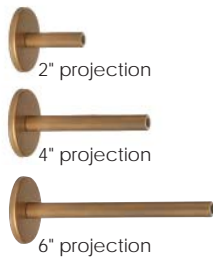

Resin Holdbacks include Resin Holdback Stems

Clark

3" DIA
1" thick
Antique Brass



2" projection	QSCKHB2
4" projection	QSCKHB4
6" projection	QSCKHB6

Trudy

4 3/4" DIA
3/4" thick
Walnut



2" projection	QSTRHB2
4" projection	QSTRHB4
6" projection	QSTRHB6

Brooks

4" DIA
1 1/4" thick
Rose Gold



2" projection	QSBRHB2
4" projection	QSBRHB4
6" projection	QSBRHB6

Miranda

5" DIA
1 1/2" thick
Platinum



2" projection	QSMIHB2
4" projection	QSMIHB4
6" projection	QSMIHB6

Resin Holdback Stems

Base: 3 1/2" DIA
Stem: 3/4" DIA
Platinum

2", 4", or 6" projection
must be selected.



2 1/4" Finials & Holdbacks ARE AVAILABLE IN 5 QUICK SHIP WOOD AND RESIN FINISHES:



PLATINUM
QSPL



WALNUT
QSWAL



ROSE GOLD
QSRG



ANTIQUe BRASS
QSAB



OIL RUBBED BRONZE
QSORB

2 1/4" Brackets, Poles, Rings & Accessories

2 1/4" Metal Brackets

Return indicates distance from wall to center of pole.



Harlan 3" Single
 QS214HASBK
 3/4" W
 3 3/4" H backplate
 4 1/8" return
 Oil Rubbed Bronze



Harlan 6" Single
 QS214HAS6BK
 3/4" W
 3 3/4" H backplate
 6" return
 Platinum



Harlan 6" Double
 QS214HADBK
 3/4" W
 3 3/4" H backplate
 6" front return
 2 3/8" back return
 Front cradle holds 2 1/4" diameter pole; back cradle holds 1 1/8" diameter pole.
 Walnut



Front view when installed.

2 1/4" Metal Inside Mount
 QS214MIBK
 1" W
 1 1/8" H
 2 1/8" D
 Antique Brass
 (Sold in pairs)



2 1/4" Metal Ceiling Mount
 QS214MCMBK
 1" W x 3 1/4" D ceiling plate
 1" W
 3 3/4" H
 3 1/4" D
 3 3/8" drop (distance from ceiling to bottom of pole)
 Oil Rubbed Bronze

2 1/4" Resin Brackets

Return indicates distance from wall to center of pole.



2 1/4" William 3" Single
 QS214WISBK
 1" W
 4" H backplate
 4 1/8" return
 Platinum



2 1/4" William 6" Single
 QS214WIS6BK
 1" W
 4" H backplate
 7 1/8" return
 Walnut



2 1/4" William 6" Double
 QS214WIDBK
 1" W
 3 3/8" H backplate
 7 1/8" front return
 3 1/4" back return
 Front cradle holds 2 1/4" diameter pole; back cradle holds 1 1/8" diameter pole.
 Rose Gold

2 1/4" Rings

Ring Drop indicates distance from bottom of pole to bottom of ring.



2 1/4" Wood Ring
 QS214WRI
 1/2" W
 2 3/8" ID
 3 3/8" OD
 7/8" drop
 Antique Brass



2 1/4" Metal Ring
 QS214MRI
 1/4" W
 2 1/2" ID
 3" OD
 1/2" drop
 Oil Rubbed Bronze

2 1/4" Accessories



36" Clear Acrylic Wand
 QSAC36WAND
 1/2" DIA
 36" L
 Acrylic, clear only



48" Clear Acrylic Wand
 QSAC48WAND
 1/2" DIA
 48" L
 Acrylic, clear only

2 1/4" Hinged Resin Elbow
 QS214REL
 2 3/8" DIA
 5 1/8" overall length
 2 1/8" length each side when bent
 Antique Brass

2 1/4" Wood Poles



Smooth
 QS214SM
 Platinum



Fluted
 QS214FL
 Platinum

2 1/4" smooth and fluted wood poles are sold in 2 foot increments. 2 foot minimum. Poles will be cut to specified lengths. Fall off will not be saved or shipped. **Maximum continuous length is 12 feet.** Every pole ships with a splicing screw.

2 1/4" Quick Ship Finials, Fascia, and Finishes available in Corded and Motorized Traverse. 10 - 15 DAY LEAD TIME. SEE PAGES 61 - 68.



Pinch Pleat

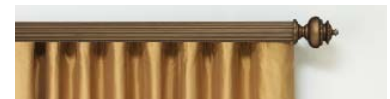

Ripplefold® Style

2 1/4" Brackets, Poles, Rings & Accessories ARE AVAILABLE IN 5 QUICK SHIP WOOD AND RESIN FINISHES:



PLATINUM
 QSPL



WALNUT
 QSWAL



ROSE GOLD
 QSRG



ANTIQUE BRASS
 QSAB



OIL RUBBED BRONZE
 QSORB

General Info

PORTFOLIO FINISHES	
AM	Amulet
AND	Andiron
AG	Antique Gold
AGL	Antique Gold Leaf
AB	Art Bronze
BW	Barnwood
BL	Black
CIN	Cinnamon
DC	Dark Chocolate
ET	Eternal
FL	Firelight
GR	Goldenrod
GOS	Gossamer
HA	Halo
JA	Java
LIN	Linen
MK	Mink
ML	Moonlight
MYS	Mystic
NAB	New Age Bronze
PAR	Parchment
SH	Shimmer
SM	Silver Maple
SPW	Spicewood
SPG	Spun Gold
ST	Starlet
TIM	Timber
TTM	Titanium
URB	Urban Bronze
WH	White
PTH PERFECT MATCH™ FINISHES	
PPMEF	Eggshell Sheen Level
PPMHGF	High-Gloss Sheen Level
PPMGLITTER	Glitter Highlights
PPMGOLD	Gold Highlights
PPMROSEGOLD	Rose Gold Highlights
PPMSILVER	Silver Highlights
QUICK SHIP FINISHES	
1" METAL	
QSAB	Antique Brass
QSNB	Brushed Nickel
QSMID	Midnight
QSORB	Oil Rubbed Bronze
QSRG	Rose Gold
LUXE LINE	
QSLXAB	Antique Brass
QSLXBN	Brushed Nickel
QSLXBK	Black
WOOD AND RESIN 1⅜" and 2¼"	
QSAB	Antique Brass
QSORB	Oil Rubbed Bronze
QSPL	Platinum
QSRG	Rose Gold
QSWAL	Walnut

Finishes

Finishes with antiquing, dusting, or glazing will vary from product to product depending on the level of detail. Areas with deeper recesses will appear darker than smooth areas.

For the best possible finish match, refer to the 2014 Paris Texas Hardware Finish Chips. These chips have smooth, fluted, and carved detailed areas, enabling you to see the beautiful shadings and highlights that make our finishes so special.

Strike-offs: For an additional fee, Paris Texas Hardware can provide a sample of your Portfolio or PTH Perfect Match™ finish on any wood or metal pole as requested. Customer approval of the strike-off sample is required before production will begin.

Touch up paint can be sent to the customer on request, for an additional charge.

Materials

Some finials, brackets, holdbacks, and rings are made of resin composite materials. Resin may be damaged by cutting, drilling, or attempting to alter the size or shape of products. Some items are made of cast aluminum or stamped steel. Wood poles and wood rings are made of various hardwoods. Metal poles and metal rings are made of steel.

Poles & Rods

Poles may be spliced together using a dowel splicing screw, which is included with each pole. We recommend a center support bracket for pole lengths in excess of four feet. We cannot guarantee against sagging caused by unsupported spans greater than our recommended four feet.

Finials & Holdbacks

All finials and holdbacks are sold as pairs. Most resin finial bases have a ⅛" recess for a clean pole fit. Resin finials are fitted with a dowel screw that may not be removed without damaging the finial

Brackets

Brackets are sold individually. Depending on the style of the bracket, there are three wall mounting styles; key lock, round mounting plate, or front drill. Some heavier treatments may require stronger fasteners (mollies and screws) than those included with the brackets. Brackets should be installed securely into wall studs.

Rings

Rings are sold individually. Eyelets are not detachable from resin rings. Excessive movement of rings on the top of the pole will naturally abrade the finish. We discourage using heavy treatments with the 1" resin rings. We recommend three to four rings per foot of finished pole length, or six to seven rings per width of fabric.

GENERAL INFO

Production Time

Purchase orders are processed once they are received by Paris Texas Hardware. Incomplete information will delay processing and shipping. Quick Ship collections are in stock and ship within 24 hours. Quick Ship orders received before noon CST ship the same day. Portfolio custom collection is hand finished and ships within 10-15 business days.

Corded and Motorized Traverse Systems

Traverse systems are available for 2" and 2¼" Portfolio and 2¼" Quick Ship Wood and Resin. Production time for traverse system orders is 10-15 business days. Please refer to pages 61-68 for available pole sizes and finishes.

Pricing and Terms

Pricing found in the Paris Texas Hardware Price List are our Suggested Retail Prices. Prices are subject to change without notice. Prices are quoted exclusive of Freight and Packaging. The Buyer should always inspect the product upon receipt.

IMPORTANT: Please note that your order will be placed with an authorized Paris Texas Hardware Distributor. While most of the following will generally apply, your distributor may have terms and conditions of the sale that will vary from what is stated here.

Returns, Changes, and Cancellations

All Portfolio and PTH Perfect Match™ products are custom painted and may not be returned. Orders may not be changed or cancelled once production has begun.

Quick Ship items may be returned if poles are uncut and all products are received in sellable condition. A restocking fee of 40% will apply and the customer will prepay freight. All returns must be authorized by the Paris Texas Hardware customer service department, and are authorized at our discretion, given the circumstances and nature of each order. A Return Authorization Number (RA#) must be issued by customer service, and the RA# must be noted on all return packages. Return Credit is issued on returned goods that are inspected and deemed undamaged. Customers should exercise care to adequately package return goods. Return Credit will not be issued for unauthorized returns or damaged returns.

Shipping

All hardware orders are shipped FOB Dallas, Texas. Poles over 100" MUST be shipped by common carrier. Please see the Paris Texas Hardware Retail Price List for applicable Freight and Packaging fees.

Damaged Goods and Freight Claims

Immediately upon receipt, your order should be inspected to ensure that there is no concealed damage from shipping. To report a claim, contact your Paris Texas Hardware distributor. Damage and freight claims must be made within 15 days of receipt of goods. Claims reported after 15 days will not be accepted. To expedite the claim process, please provide your distributor with the following information: purchase order number, Paris Texas Hardware order number, shipping phone number and address, and a complete list of damaged items. Freight companies require all packaging materials and damaged items to be kept for inspection. Merchandise damaged in shipping will be replaced. Our policy is that we replace damaged product per the original order.

Please note on the Bill of Lading If there is any possibility of concealed damage.

Installation

We recommend using a professional installer. Installation hardware is included. The fasteners (screws and mollies) may not be appropriate for every installation or wall material. Brackets and holdbacks should be installed securely into wall studs when possible. Paris Texas Hardware will not assume responsibility for damages incurred by improperly mounted or inadequately supported hardware.

— *Special thanks to Duralee and RM Coco for providing many of the gorgeous fabrics featured in our catalog.*



EasyPull™ Traverse Order Form



PO # _____ Side Mark _____ Ship via _____

Company Information		Shipping Information	
Company Name	Acct #	Company Name	Acct #
Contact Person		Contact Person	
Street Address		Street Address	
City	State	City	State
Email	ZIP	Email	ZIP
Phone	Fax	Phone	Fax

EasyPull™ TRAVERSE SYSTEMS - Consult Price List for detailed specifications.

Item #	System Length (per 2')	Custom Cut Length	Fascia Pole Diameter	Smooth	Futed	Fascia Finish Code	Bracket Preference	Draw Preference		Cord Length (if over 72")	Qty	Price per Unit	Subtotal
								Center	One-way				
				<input type="checkbox"/>	<input type="checkbox"/>			<input type="checkbox"/> L	<input type="checkbox"/> R				
				<input type="checkbox"/>	<input type="checkbox"/>			<input type="checkbox"/> L	<input type="checkbox"/> R				
				<input type="checkbox"/>	<input type="checkbox"/>			<input type="checkbox"/> L	<input type="checkbox"/> R				

EasyPull™ TRAVERSE COORDINATING ACCESSORIES - Order finials, extra brackets, and accessories here.

Item #	Finish Code	Description	Qty	Price per Unit	Subtotal

Additional Information

PTH Perfect Match™												
Color #	Color Name											
Highlights	Sheen Level											
	<input type="checkbox"/> High-Gloss <input type="checkbox"/> Eggshell											

SPECIAL INSTRUCTIONS

Quantity included per set based on cut pole length

	6'	7'	8'	9'	10'	11'	12'	13'	14'	15'	16'	17'	18'	19'	20'
Glides [4 per foot, includes master carriers (2) & end caps (2)]	24	28	32	36	40	44	48	52	56	60	64	68	72	76	80
Brackets (1 per every 3-4 feet)	3	3	4	4	4	5	5	5	6	6	6	7	7	7	8



Heavy-Duty Ball Bearing Corded Traverse Order Form

PO #	Side Mark	Ship via
-------------	------------------	-----------------

Company Information		Shipping Information	
Company Name	Acct #	Company Name	Acct #
Contact Person		Contact Person	
Street Address		Street Address	
City	State	City	State
Email	ZIP	Email	ZIP
Phone	Fax	Phone	Fax

HEAVY-DUTY BALL BEARING TRAVERSE SYSTEMS - Consult Price List for detailed specifications.															
Item #	System Length (per 2')	Custom Cut Length	Fascia Pole Diameter	Fluted	Smooth	Fascia Finish Code	Bracket Preference	Draw Preference		Cord Location	Cord Length (standard: 120")	Carrier pinch pleat OR Ripplefold® style*	Qty	Price per Unit	Subtotal
								Center	One-way						
				<input type="checkbox"/>	<input type="checkbox"/>			<input type="checkbox"/>	<input type="checkbox"/>	<input type="checkbox"/>	<input type="checkbox"/>	<input type="checkbox"/>			
				<input type="checkbox"/>	<input type="checkbox"/>			<input type="checkbox"/>	<input type="checkbox"/>	<input type="checkbox"/>	<input type="checkbox"/>	<input type="checkbox"/>			
				<input type="checkbox"/>	<input type="checkbox"/>			<input type="checkbox"/>	<input type="checkbox"/>	<input type="checkbox"/>	<input type="checkbox"/>	<input type="checkbox"/>			

HEAVY-DUTY BALL BEARING TRAVERSE COORDINATING ACCESSORIES - Order finalials, extra brackets, and accessories here.			
Item #	Finish Code	Description	Price per Unit

Additional Information																			
Quantity included per set based on cut pole length				4'	6'	7'	8'	9'	10'	11'	12'	13'	14'	15'	16'	17'	18'	19'	20'
Slides [4 per foot, includes master carriers (2) & end caps (2)]				16	24	28	32	36	40	44	48	52	56	60	64	68	72	76	80
Brackets (1 per every 3-4 feet)				2	3	3	4	4	4	5	5	5	6	6	6	7	7	7	8

SPECIAL INSTRUCTIONS

**When ordering Ripplefold® style carriers, answer these questions:*

1. Select Ripplefold® style fullness: 80% 100% 120%

2. Select Ripplefold® style masters: Buttmaster Overlap

PTH Perfect Match™			
Color #		Color Name	
Highlights		Sheen Level	
		<input type="checkbox"/> High-Gloss <input type="checkbox"/> Eggshell	



Motorized Traverse Order Form



PO #	Side Mark	Ship via
-------------	------------------	-----------------

Company Information		Shipping Information	
Company Name	Acct #	Company Name	Acct #
Contact Person		Contact Person	
Street Address		Street Address	
City	State	City	State
Email	ZIP	Email	ZIP
Phone	Fax	Phone	Fax

MOTORIZED TRAVERSE SYSTEMS - Consult Price List for detailed specifications. <small>Specified custom cut length indicates track length including drive gears; fascia will be 1/4" longer at each end of track (12" total); mitered fascia will be 1/2" longer at each end of track (3" total).</small>														
Item #	System Length (6'-40)*	Custom Cut Length	Fascia Pole Diameter	Smooth		Fascia Finish Code	Bracket Preference	Draw Preference Center	Motor Type	Motor Location L R	Carrier pinch pleat OR Ripplefold® style**	Price per Unit	Qty	Subtotal
				Fitted	Flt									
				<input type="checkbox"/>	<input type="checkbox"/>			<input type="checkbox"/> L <input type="checkbox"/> R						
				<input type="checkbox"/>	<input type="checkbox"/>			<input type="checkbox"/> L <input type="checkbox"/> R						
				<input type="checkbox"/>	<input type="checkbox"/>			<input type="checkbox"/> L <input type="checkbox"/> R						

MOTORIZED TRAVERSE COORDINATING ACCESSORIES - Order finials, additional motors for tandem applications, and accessories here.			
Item #	Finish Code	Description	Subtotal

PTH Perfect Match™	
Color #	Color Name
Highlights	Sheen Level
	<input type="checkbox"/> High-Gloss <input type="checkbox"/> Eggshell

* BTX-DC-60 and BTX-DC-120 Systems are available in continuous lengths up to 20' and in spliced lengths up to 40'.
 BTX-DCS-45 Systems are available in continuous lengths up to 18'.
 Somfy Glydea 35 Systems are available in continuous lengths up to 20' and in spliced lengths up to 32'.
 Somfy Glydea 60e Systems are available in continuous lengths up to 20' and in spliced lengths up to 36'.
 For a system more than the maximum spliced length, two one-way systems can butt against each other behind fascia. Must be specified.
 ** Ripplefold® style carriers incur a 10% upcharge per track. Must specify carrier fullness.

SPECIAL INSTRUCTIONS

**When ordering Ripplefold® style carriers, answer these questions:

1. Select Ripplefold® style fullness: 80% 100% 120%

2. Select Ripplefold® style masters: Buttmaster Overlap



For your convenience, you can unfold this cover to view all of our standard finishes as you browse our product catalog.

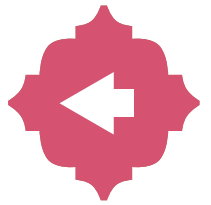

Portfolio *ships in 10 - 15 business days*
 CUSTOM HAND-PAINTED FINISHES



TIMBER (TIM)



SILVER MAPLE (SM)



PARCHMENT (PAR)



ANDIRON (AND)



LINEN (LIN)



SPICEWOOD (SPW)



TITANIUM (TTM)



URBAN BRONZE (URB)



AMULET (AM)



DARK CHOCOLATE (DC)



ANTIQUÉ GOLD (AG)



ETERNAL (ET)



CINNAMON (CIN)



JAVA (JA)



STARLET (ST)



ANTIQUÉ GOLD LEAF (AGL)



GOSSAMER (GOS)



SPUN GOLD (SPG)



NEW AGE BRONZE (NAB)



FIRELIGHT (FL)



SHIMMER (SH)



GOLDENROD (GR)



BARNWOOD (BW)



WHITE (WH)



ART BRONZE (AB)



MYSTIC (MYS)



HALO (HA)



MINK (MK)



MOONLIGHT (ML)



BLACK (BL)

Quick Ship *ships in 1 business day*

METAL FINISHES



BRUSHED NICKEL
QSBN



MIDNIGHT
QSMID



ROSE GOLD
QSRG

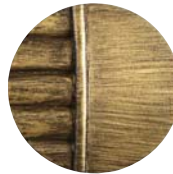

ANTIQUÉ BRASS
Q SAB



OIL RUBBED BRONZE
QSORB

LUXE LINE FINISHES



BRUSHED NICKEL
QSLXBN



BLACK
QSLXBK



ANTIQUÉ BRASS
QSLXAB

WOOD AND RESIN FINISHES



PLATINUM
QSP



WALNUT
QSWAL



ROSE GOLD
QSRG



ANTIQUÉ BRASS
Q SAB

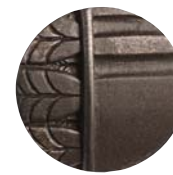

OIL RUBBED BRONZE
QSORB

Photography may not accurately represent the true color of a finish. A finish may show slight variation when painted on different materials, such as wood or steel. For best possible finish match, please refer to the actual sample chip.



Midwest
Designer
Supply

www.midwestdesignersupply.com

888-523-2611
262-524-1007 (fax)



**PARIS TEXAS
HARDWARE**

www.paristexashardware.com